



PRODUCT CATALOG **2018**

LYON[®]
Cabinets • Lockers • Shelving

TABLE OF CONTENTS



Modular Drawer Cabinets (MDC)	
Features	1
Ordering Guide.....	2
Pre-Engineered Modular Drawer Cabinets.....	3-13
Pre-Engineered Overhead Units.....	14-15
Pre-Engineered Mobile Cabinets	16
Pre-Engineered Workstations	17
Pre-Engineered Modular Drawers in Shelving	18
Custom Design Modular Drawers in Shelving.....	19
Pre-Engineered Modular Drawer Work Bench Kits	20-21
Modular Drawer Cabinet Accessories	22-25
Weapons Storage.....	26-27
All-Welded Cabinets	
Storage Cabinets.....	28
Combination Cabinets.....	29
Counter High and Eye-Level Shelf Cabinets.....	29
Clearview and 4-Door Shelf Cabinets	30
Mobile Shelf Cabinet and Mobile Work Centers.....	31
Cabinets w/Removable Bins.....	32-33
Deep Door Cabinets w/Removable Tilt Bins.....	34-35
Maintenance Centers w/Modular Drawers.....	36-37
Economical Storage Cabinets	
1000 Series, Counter High and Standard Cabinets	38
Combination Wardrobe and Wardrobe.....	39
Visible Storage Cabinets	
Visible Storage Cabinets.....	40-41
Shelving Storage	
Selection Guide.....	42
8000 Series Specifications.....	43
8000 Series Features and Load Capacities	44
8000 Series 36" Wide Open/Closed Shelving.....	45
8000 Series 42" and 48" Wide Shelving	46
8000 Series Galvanized Shelving.....	47
8000 Series Wire Shelving	48
8000 Series 36" Wide Counter Shelving.....	49
8000 Series Steel Mounting Panel and Swing Doors.....	49
8000 Series Shelving Accessories	50-51
36" Wide Drawers in Shelving.....	52-53
Shelving Parts and Components.....	54-55
Pre-Engineered 36" Wide Bin Shelving	56
Stand Alone Offset Angle Shelving.....	57
Project Clip Open/Closed Shelving.....	58-59
Project Clip Shelving Components	60-61
Storage Racking Systems	
Pre-Engineered Bulk Storage Rack.....	62-63
Bulk Storage Rack Ordering Guide.....	64
Bulk Storage Rack Assembly and Beams.....	65
Bulk Storage Rack Decking and Accessories.....	66-67
Bulk Storage Rack Additional Levels and Decking.....	68
Pre-Engineered Record Storage Racks	69
Rivet Rack and Components	70-71
Pallet Rack.....	72-76
Bar Pipe and Rod Rack.....	77
Cantilever Rack.....	78-80
Specialty Storage	
Slotted Angle	81
Safety Storage	
Safety Storage Selection Guide	82
Choosing the Right Cabinet.....	83
Flammable Liquid Cabinets.....	84
Acids and Corrosives Cabinets.....	85
Paints and Inks and Pesticide Cabinets.....	86
HazMat Response Cabinets.....	87
Steel Lockers	
Standard Steel Lockers.....	88-89
Two Persons Lockers and LockeRack®	90
Antimicrobial Lockers.....	91
Locker Accessories.....	92-93
Locker Room Benches	94
TA-50 Gear and Command Gear Lockers.....	95
Valor™ Law Enforcement Lockers.....	96-97
Athletic Lockers	98-99
Specialty Lockers.....	100
ExchangeMaster® Lockers	101-103

Organized Storage

Designed for Efficiency, Engineered for Strength!

Customizing the Right Storage Solution - Contact us with your special requirements; Lyon's engineering and manufacturing departments will develop a unique modular drawer cabinet to fit your special application.

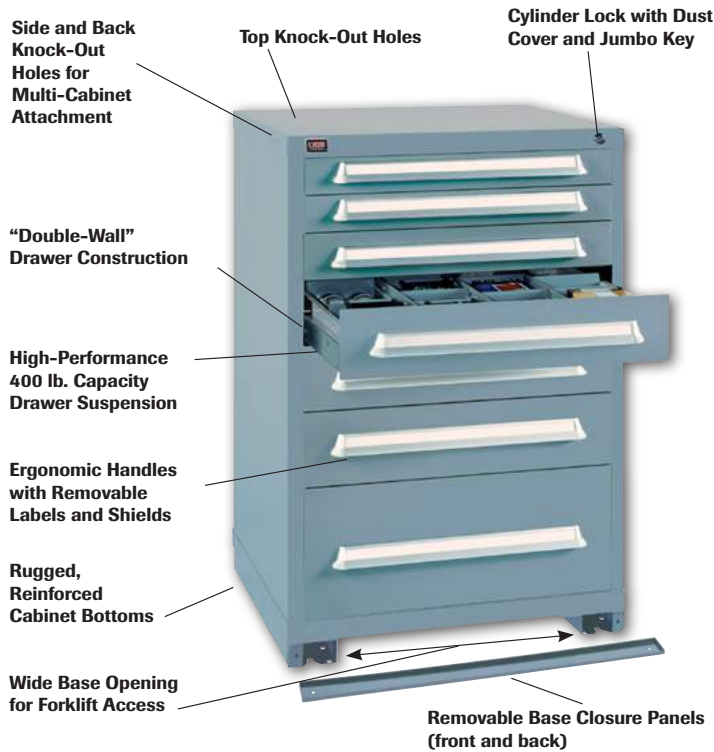

Why Choose Lyon Modular Drawer Cabinets...

...to provide you with the highest density storage solution for small to mid-sized products, while reducing your storage footprint by as much as 50%.

Performance

The Lyon drawer suspension features the highest quality glides resulting in the "smoothest", most reliable operating drawers in the industry, empty and fully loaded.

Accessibility

Full extension drawers provide 100% visibility to the stored product. Lyon drawers are ergonomically engineered to provide the best possible human reach points.

Efficiency

Drawer interiors can be sub-divided into compartments for the storage of parts without cartons. Neat and organized storage improves inventory control.

Security

Choose from many different types of latching systems to provide for the safe secure storage of valuable products.

Modularity

Flexible design based on a "Building-Block" approach. From pre-engineered to custom-built products, Lyon offers an innovative array of easy order options to adapt to your future growth.

NOTE:

With a fully loaded (400 lbs.) drawer capacity, Lyon averaged 8,000 cycles compared to 4,000 competitive cycles before drawer push-pull forces exceeded 50 lbs.

MODULAR DRAWER CABINETS

15 Drawer Heights

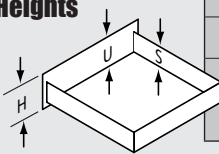

Drawer Number	04	05	06	07	08	09	10	11	12	13	14	15	16	17	18	
"U" Usable Height	2-1/4"	3"	3-7/8"	4-5/8"	5-3/8"	6-1/4"	7"	7-3/4"	8-1/2"	9-3/8"	10-1/8"	10-7/8"	11-3/4"	12-1/2"	13-1/4"	
"S" Side Height	1-7/8"	3"	4-3/8"				6-1/4"									
"H" Front Height	3-1/16"	3-7/8"	4-5/8"	5-7/16"	6-3/16"	7"	7-3/4"	8-9/16"	9-3/8"	10-1/8"	10-7/8"	11-3/4"	12-1/2"	13-5/16"	14-1/16"	

6 Housing Heights

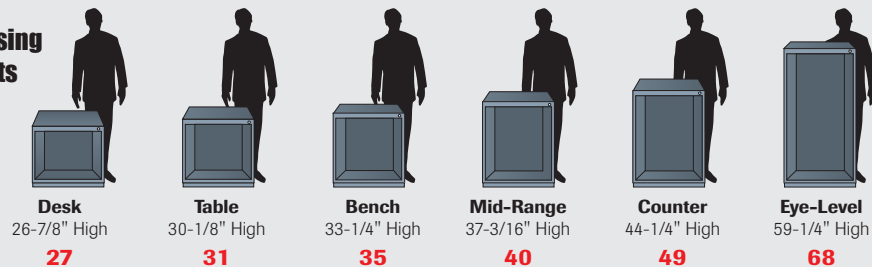

Desk 26-7/8" High **27**
Table 30-1/8" High **31**
Bench 33-1/4" High **35**
Mid-Range 37-3/16" High **40**
Counter 44-1/4" High **49**
Eye-Level 59-1/4" High **68**

5 Housing Footprints

All pre-configured cabinets are 30" wide. If you need additional footprint sizes, please contact your district manager or customer service at 800-323-0082.

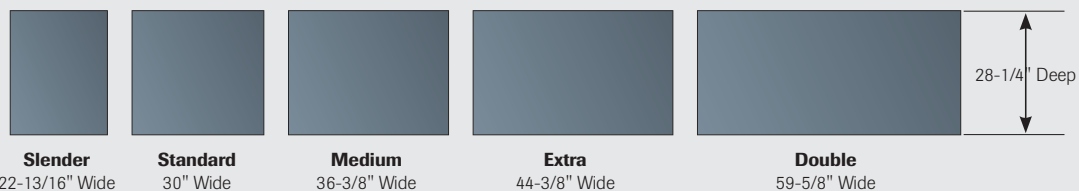

Slender 22-13/16" Wide
Standard 30" Wide
Medium 36-3/8" Wide
Extra 44-3/8" Wide
Double 59-5/8" Wide



PRE-ENGINEERED MODULAR DRAWER CABINET (MDC) ORDERING GUIDE

Lyon's hand picked Pre-Engineered Modular Drawer 30" Wide Standard Cabinets meet the most popular workspace requirements. To complete an item number, follow the steps and see example below:

Step 1

Choose from 6 housing heights: Desk, Table, Bench, Mid-Range, Counter, or Eye-level on pages 3-11.

Step 2

Choose housing and drawer colors from the 49 cabinet/drawer-door color combinations below

2a. Enter the **LETTER** designation for the **HOUSING** color

2b. Enter the **LETTER** designation for the **DRAWER** color

Step 3

Choose drawer access requirements

Enter **S** for **SINGLE** drawer access (**SDA**)

Enter **M** for **MULTIPLE** drawer access (**MDA**)

Enter **N** for **No SDA or MDA** drawer access

Step 4

Choose layout kit installation

Enter **I** for **INSTALLED KIT**

Enter **K** for **KITTED KITS**

Enter **0** for **NO KITS**

Step 5

Choose locking requirements

Enter **N** for **NO LOCKING SYSTEM**

Enter **L** for **STANDARD LOCKING SYSTEM**

Enter **1, 2, 3, 4 or 5** for **KEYED ALIKE LOCKING SYSTEM LOCKS**

Example

The catalog number for the pre-engineered cabinet shown in the illustration below is a Mid-Range 37-3/16"h Cabinet with 6 drawers and 144 compartments from page 6 featuring Vulcan Black housing with Dove Gray drawers, single drawer access, 1 keyed alike locking system and layout kits installed would be: **KDS40303010011**

Drawer Number

designated in the chart at the bottom of this page.

Layout Kit Numbers

designates the drawer interior configuration which can be found on pages 12 & 13.

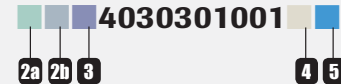
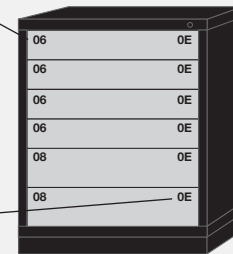

Color Selection



Drawer Number	04	05	06	07	08	09	10	11	12	13	14	15	16	17	18
Usable Height	2-1/4"	3"	3-7/8"	4-5/8"	5-3/8"	6-1/4"	7"	7-3/4"	8-1/2"	9-3/8"	10-1/8"	10-7/8"	11-3/4"	12-1/2"	13-1/4"
Side Height	1-7/8"		3"		4-3/8"			6-1/4"							

MDC

Modular Drawer Cabinets

All Pre-Engineered Modular Drawer 30" Wide Standard Cabinets on this page feature:

- Fork Lift Base

Compartment quantities under each cabinet is based on choosing the layout kit option as noted in step 4 on page 2. Standard cabinet layout kits can be found pages 12 and 13.

DESK HEIGHT – 26-7/8" H x 28-1/4" D

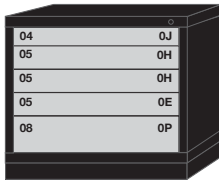

5 drawers with
144 compartments

■ ■ ■ ■ ■ **273030000B** ■ ■ ■ ■ ■

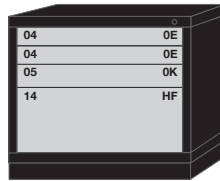

4 drawers with
70 compartments

■ ■ ■ ■ ■ **2730301004** ■ ■ ■ ■ ■

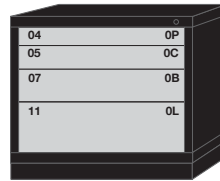

4 drawers with
41 compartments

■ ■ ■ ■ ■ **2730301001** ■ ■ ■ ■ ■

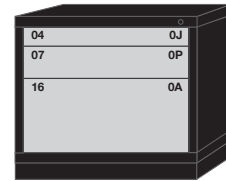

3 drawers with
50 compartments

■ ■ ■ ■ ■ **273030000A** ■ ■ ■ ■ ■

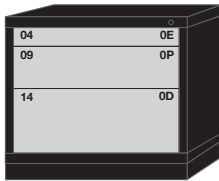

3 drawers with
48 compartments

■ ■ ■ ■ ■ **2730301007** ■ ■ ■ ■ ■

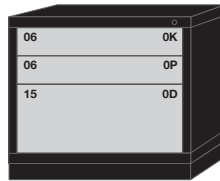

3 drawers with
44 compartments

■ ■ ■ ■ ■ **2730301008** ■ ■ ■ ■ ■

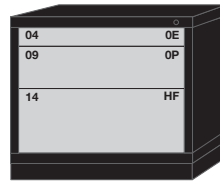

3 drawers with
42 compartments

■ ■ ■ ■ ■ **2730301005** ■ ■ ■ ■ ■

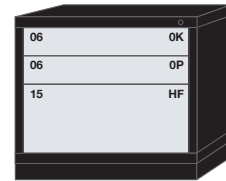

3 drawers with
38 compartments

■ ■ ■ ■ ■ **2730301006** ■ ■ ■ ■ ■

Drawer Number	04	05	06	07	08	09	10	11	12	13	14	15	16	17	18
Usable Height	2-1/4"	3"	3-7/8"	4-5/8"	5-3/8"	6-1/4"	7"	7-3/4"	8-1/2"	9-3/8"	10-1/8"	10-7/8"	11-3/4"	12-1/2"	13-1/4"
Side Height	1-7/8"		3"		4-3/8"			6-1/4"							



MDC

Modular Drawer Cabinets

All Pre-Engineered Modular Drawer 30" Wide Standard Cabinets on this page feature:
 • Fork Lift Base
 Compartment quantities under each cabinet is based on choosing the layout kit option as noted in step 4 on page 2. Standard cabinet layout kits can be found pages 12 and 13.

TABLE HEIGHT – 30-1/8" H x 28-1/4" D

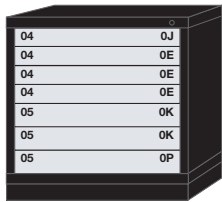

7 drawers with 160 compartments

313030000A

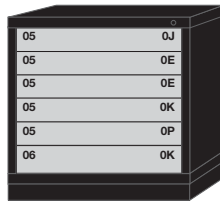

6 drawers with 136 compartments

3130301014

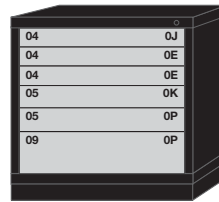

6 drawers with 132 compartments

3130301010

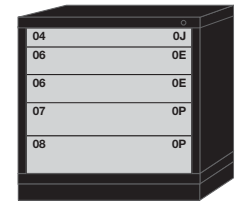

5 drawers with 112 compartments

313030000B

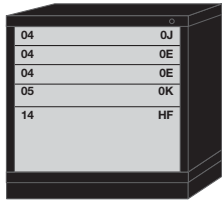

5 drawers with 108 compartments

3130301011

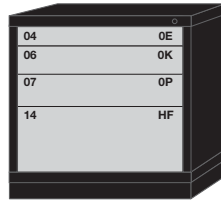

4 drawers with 68 compartments

3130301001

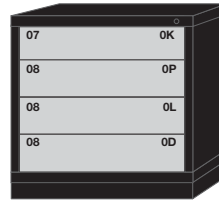

4 drawers with 56 compartments

3130301002

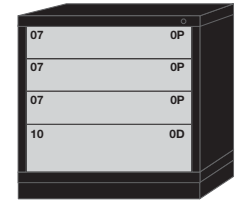

4 drawers with 56 compartments

3130301012

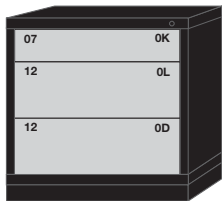

3 drawers with 40 compartments

3130301003

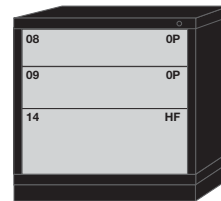

3 drawers with 40 compartments

3130301013

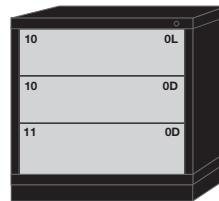

3 drawers with 28 compartments

3130301004

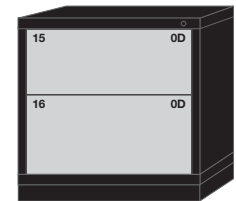

2 drawers with 16 compartments

3130301005

Drawer Number	04	05	06	07	08	09	10	11	12	13	14	15	16	17	18
Usable Height	2-1/4"	3"	3-7/8"	4-5/8"	5-3/8"	6-1/4"	7"	7-3/4"	8-1/2"	9-3/8"	10-1/8"	10-7/8"	11-3/4"	12-1/2"	13-1/4"
Side Height	1-7/8"		3"		4-3/8"			6-1/4"							

MDC

Modular Drawer Cabinets

All Pre-Engineered Modular Drawer 30" Wide Standard Cabinets on this page feature:

- Fork Lift Base

Compartment quantities under each cabinet is based on choosing the layout kit option as noted in step 4 on page 2. Standard cabinet layout kits can be found pages 12 and 13.

BENCH HEIGHT – 33-1/4" H x 28-1/4" D

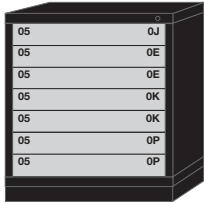

7 drawers with 152 compartments

3530301001

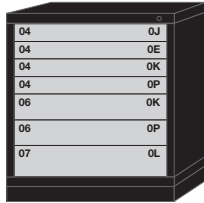

7 drawers with 140 compartments

3530301018

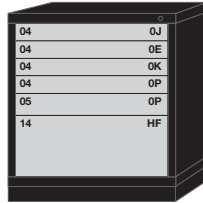

6 drawers with 110 compartments

3530301026

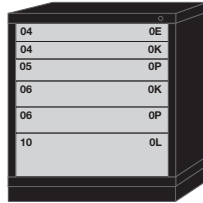

6 drawers with 108 compartments

3530301002

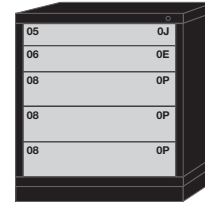

5 drawers with 104 compartments

353030000B

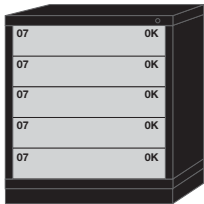

5 drawers with 100 compartments

3530301025

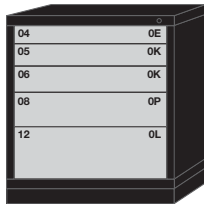

5 drawers with 92 compartments

3530301003

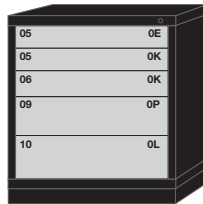

5 drawers with 92 compartments

3530301004

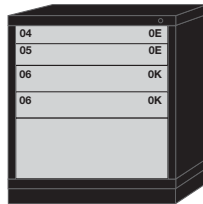

5 drawers with 90 compartments

3530301029

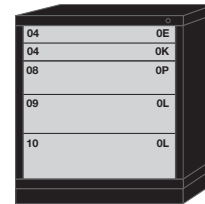

5 drawers with 84 compartments

3530301028

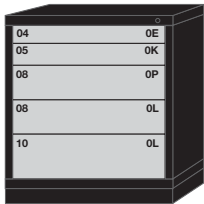

5 drawers with 84 compartments

3530301027

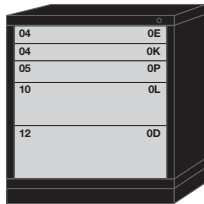

5 drawers with 80 compartments

3530301023

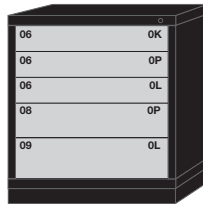

5 drawers with 76 compartments

3530301007

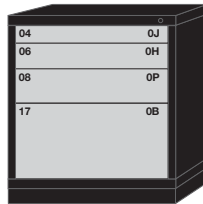

4 drawers with 88 compartments

353030000A

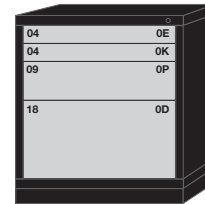

4 drawers with 68 compartments

3530301030

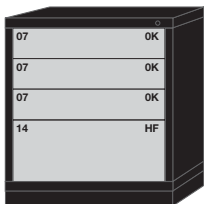

4 drawers with 62 compartments

3530301032

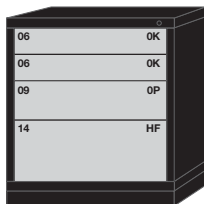

4 drawers with 58 compartments

3530301031

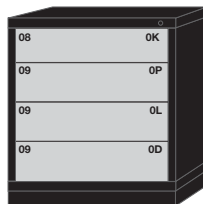

4 drawers with 56 compartments

3530301008

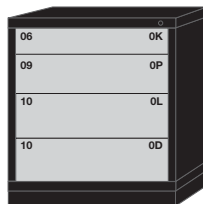

4 drawers with 56 compartments

3530301024

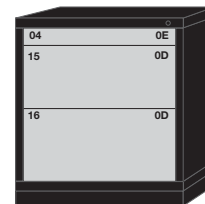

3 drawers with 40 compartments

3530301009

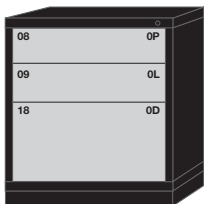

3 drawers with 36 compartments

3530301021

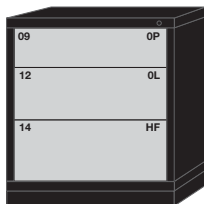

3 drawers with 30 compartments

3530301010

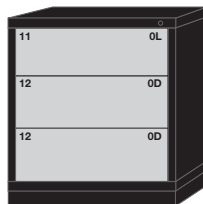

3 drawers with 28 compartments

3530301033

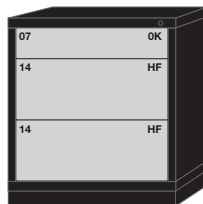

3 drawers with 24 compartments

3530301034

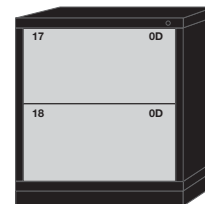

2 drawers with 16 compartments

3530301005

Drawer Number	Usable Height	Side Height
04	2-1/4"	1-7/8"
05	3"	
06	3-7/8"	3"
07	4-5/8"	
08	5-3/8"	4-5/8"
09	6-1/4"	
10	7"	6-1/4"
11	7-3/4"	
12	8-1/2"	
13	9-3/8"	
14	10-1/8"	
15	10-7/8"	
16	11-3/4"	
17	12-1/2"	
18	13-1/4"	



MDC

Modular Drawer Cabinets

All Pre-Engineered Modular Drawer 30" Wide Standard Cabinets on this page feature:

- Fork Lift Base

Compartment quantities under each cabinet is based on choosing the layout kit option as noted in step 4 on page 2. Standard cabinet layout kits can be found pages 12 and 13.

MID-RANGE – 37-3/16" H x 28-1/4" D

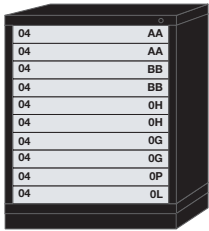

10 drawers with 342 compartments

4030301010



8 drawers with 176 compartments

403030000A

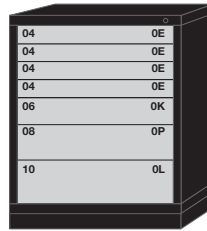

7 drawers with 144 compartments

4030301007

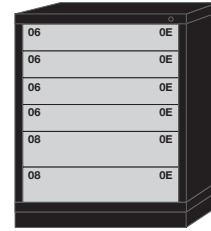

6 drawers with 144 compartments

4030301001

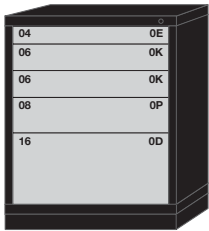

5 drawers with 88 compartments

4030301003

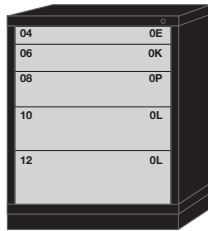

5 drawers with 84 compartments

4030301011

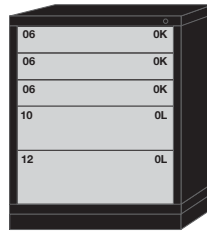

5 drawers with 84 compartments

4030301012

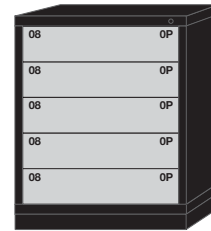

5 drawers with 80 compartments

4030301002

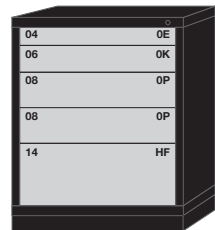

5 drawers with 78 compartments

4030301013

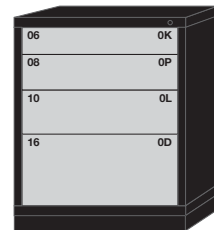

4 drawers with 56 compartments

4030301005

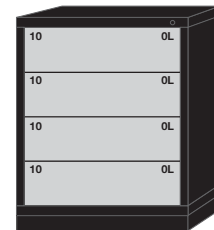

4 drawers with 48 compartments

4030301004

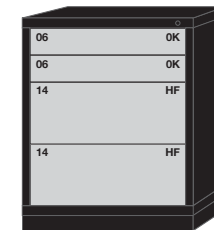

4 drawers with 44 compartments

4030301014

Drawer Number	04	05	06	07	08	09	10	11	12	13	14	15	16	17	18
Usable Height	2-1/4"	3"	3-7/8"	4-5/8"	5-3/8"	6-1/4"	7"	7-3/4"	8-1/2"	9-3/8"	10-1/8"	10-7/8"	11-3/4"	12-1/2"	13-1/4"
Side Height	1-7/8"		3"		4-3/8"			6-1/4"							

MDC

Modular Drawer Cabinets

All Pre-Engineered Modular Drawer 30" Wide Standard Cabinets on this page feature:

- Fork Lift Base

Compartment quantities under each cabinet is based on choosing the layout kit option as noted in step 4 on page 2. Standard cabinet layout kits can be found pages 12 and 13.

COUNTER – 44-1/4" H x 28-1/4" D

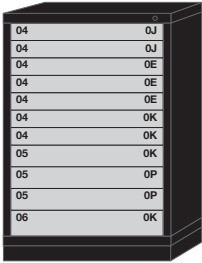

11 drawers with 248 compartments
■ ■ ■ **4930301001** ■ ■ ■

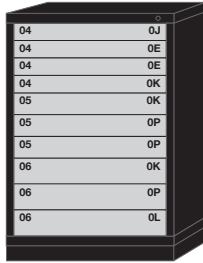

10 drawers with 200 compartments
■ ■ ■ **4930301002** ■ ■ ■

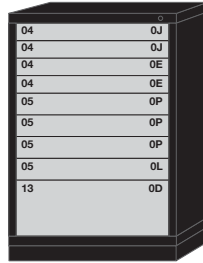

9 drawers with 180 compartments
■ ■ ■ **493030000B** ■ ■ ■

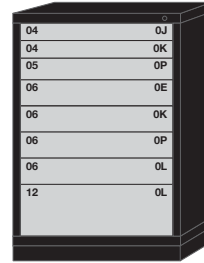

8 drawers with 152 compartments
■ ■ ■ **4930301005** ■ ■ ■

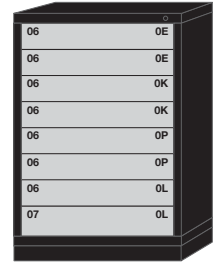

8 drawers with 144 compartments
■ ■ ■ **4930301004** ■ ■ ■

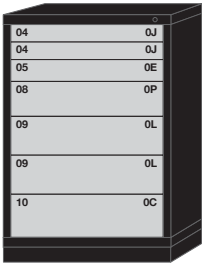

7 drawers with 137 compartments
■ ■ ■ **493030000D** ■ ■ ■

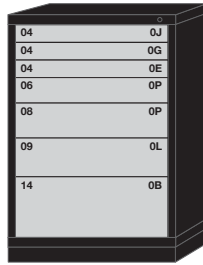

7 drawers with 129 compartments
■ ■ ■ **493030000E** ■ ■ ■

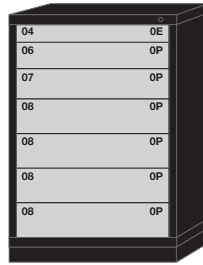

7 drawers with 120 compartments
■ ■ ■ **493030000F** ■ ■ ■

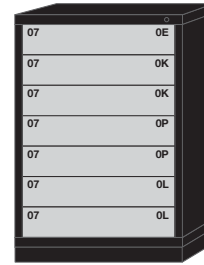

7 drawers with 120 compartments
■ ■ ■ **4930301006** ■ ■ ■

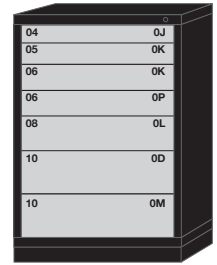

7 drawers with 114 compartments
■ ■ ■ **4930301018** ■ ■ ■

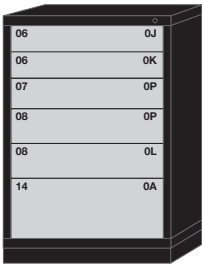

6 drawers with 98 compartments
■ ■ ■ **4930301012** ■ ■ ■

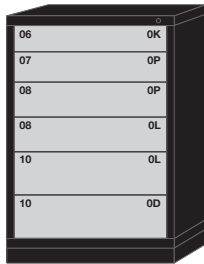

6 drawers with 84 compartments
■ ■ ■ **4930301008** ■ ■ ■

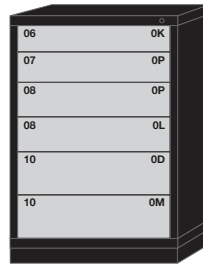

6 drawers with 78 compartments
■ ■ ■ **493030000C** ■ ■ ■

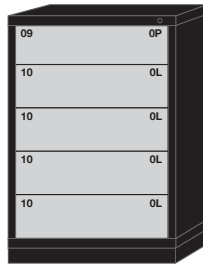

5 drawers with 64 compartments
■ ■ ■ **4930301019** ■ ■ ■

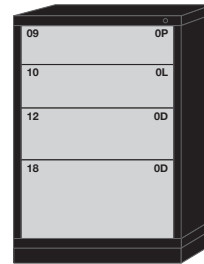

4 drawers with 44 compartments
■ ■ ■ **4930301009** ■ ■ ■

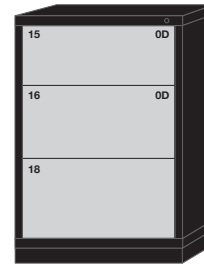

3 drawers with 17 compartments
■ ■ ■ **4930301027** ■ ■ ■

Drawer Number	04	05	06	07	08	09	10	11	12	13	14	15	16	17	18
Usable Height	2-1/4"	3"	3-7/8"	4-5/8"	5-3/8"	6-1/4"	7"	7-3/4"	8-1/2"	9-3/8"	10-1/8"	10-7/8"	11-3/4"	12-1/2"	13-1/4"
Side Height	1-7/8"		3"		4-3/8"			6-1/4"							



MDC

Modular Drawer Cabinets

All Pre-Engineered Modular Drawer 30" Wide Standard Cabinets on this page feature:

- Fork Lift Base

Compartment quantities under each cabinet is based on choosing the layout kit option as noted in step 4 on page 2. Standard cabinet layout kits can be found pages 12 and 13.

EYE-LEVEL – 59-1/4" H x 28-1/4" D

Drawer Number	Usable Height	Side Height
04	2-1/4"	1-7/8"
05	3"	
06	3-7/8"	3"
07	4-5/8"	
08	5-3/8"	4-5/8"
09	6-1/4"	
10	7"	6-1/4"
11	7-3/4"	
12	8-1/2"	
13	9-3/8"	
14	10-1/8"	
15	10-7/8"	
16	11-3/4"	
17	12-1/2"	
18	13-1/4"	

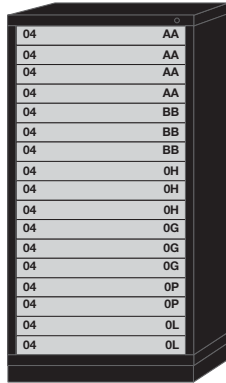

17 drawers with 591 compartments

683030000A

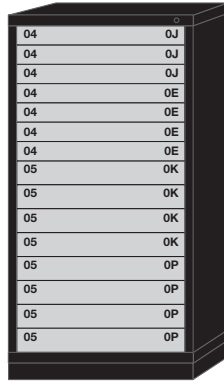

15 drawers with 336 compartments

6830301001

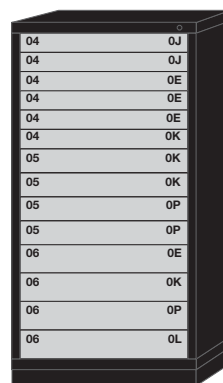

14 drawers with 300 compartments

6830301002

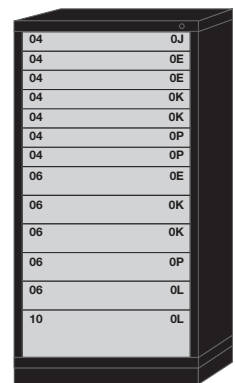

13 drawers with 256 compartments

6830301003

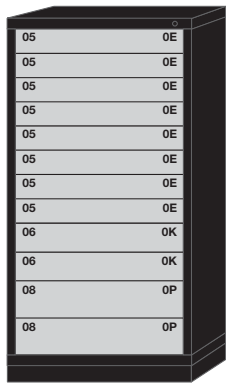

12 drawers with 264 compartments

6830301024

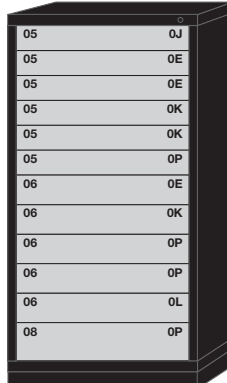

12 drawers with 240 compartments

6830301005

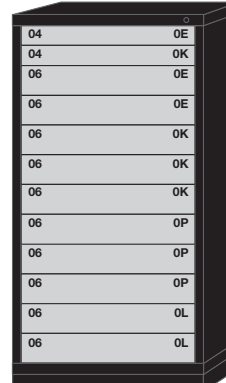

12 drawers with 224 compartments

6830301004

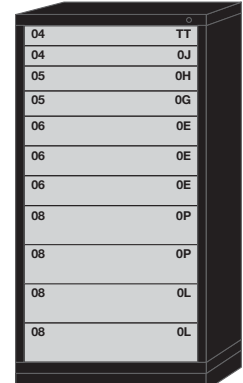

11 drawers with 269 compartments

683030000F

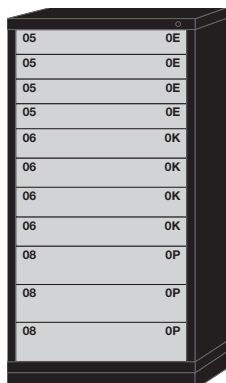

11 drawers with 224 compartments

6830301026

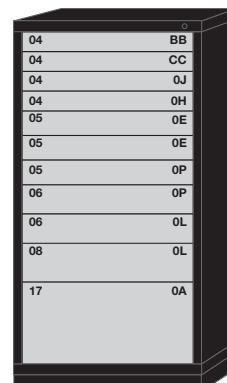

11 drawers with 222 compartments

683030000B

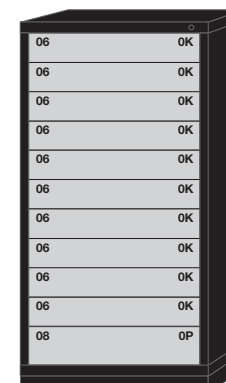

11 drawers with 216 compartments

6830301025

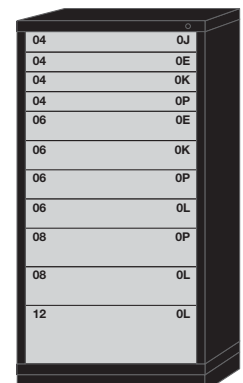

11 drawers with 204 compartments

6830301008

MDC

Modular Drawer Cabinets

All Pre-Engineered Modular Drawer 30" Wide Standard Cabinets on this page feature:

- Fork Lift Base

Compartment quantities under each cabinet is based on choosing the layout kit option as noted in step 4 on page 2. Standard cabinet layout kits can be found pages 12 and 13.

EYE-LEVEL – 59-1/4" H x 28-1/4" D

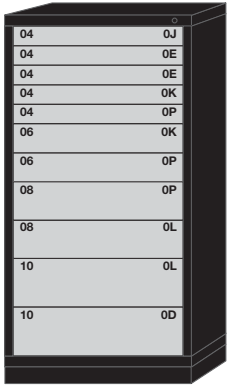

11 drawers with
200 compartments
6830301007

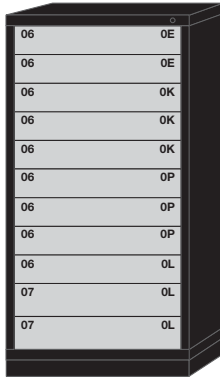

11 drawers with
192 compartments
6830301006

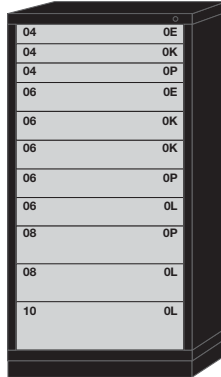

11 drawers with
192 compartments
6830301019

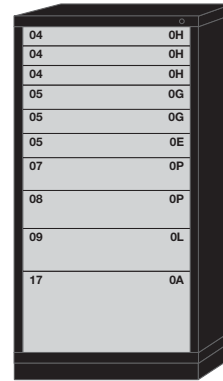

10 drawers with
228 compartments
683030000K

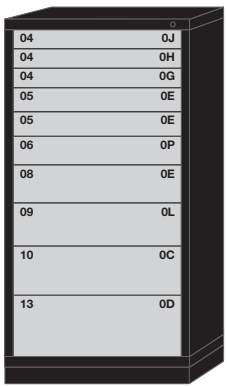

10 drawers with
210 compartments
683030000H

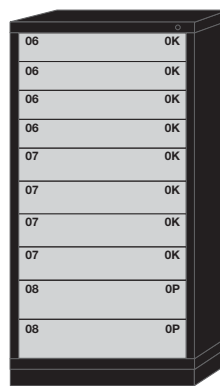

10 drawers with
192 compartments
6830301027

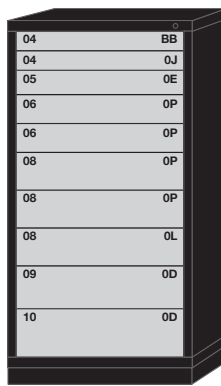

10 drawers with
180 compartments
683030000C

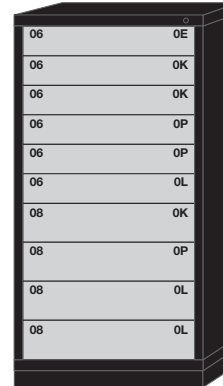

10 drawers with
168 compartments
6830301009

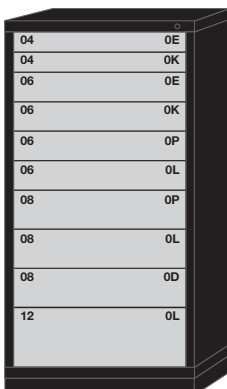

10 drawers with
164 compartments
6830301010

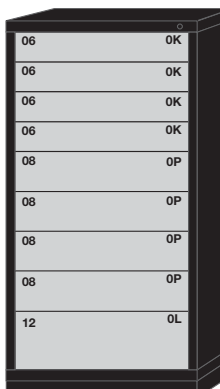

9 drawers with
156 compartments
6830301028

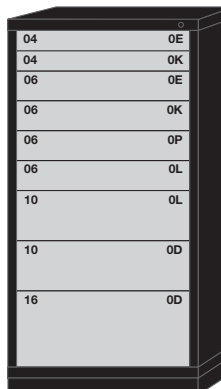

9 drawers with
144 compartments
6830301013

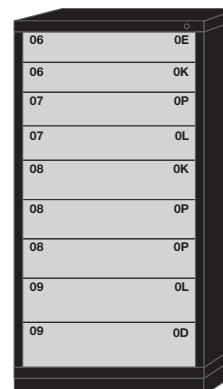

9 drawers with
144 compartments
6830301011

Drawer Number	Usable Height	Side Height
04	2-1/4"	1-7/8"
05	3"	3"
06	3-7/8"	
07	4-5/8"	4-5/8"
08	5-3/8"	
09	6-1/4"	6-1/4"
10	7"	
11	7-3/4"	
12	8-1/2"	
13	9-3/8"	
14	10-1/8"	
15	10-7/8"	
16	11-3/4"	
17	12-1/2"	
18	13-1/4"	



MDC

Modular Drawer Cabinets

All Pre-Engineered Modular Drawer 30" Wide Standard Cabinets on this page feature:

- Fork Lift Base

Compartment quantities under each cabinet is based on choosing the layout kit option as noted in step 4 on page 2. Standard cabinet layout kits can be found pages 12 and 13.

EYE-LEVEL – 59-1/4" H x 28-1/4" D

Drawer Number	Usable Height	Side Height
04	2-1/4"	1-7/8"
05	3"	
06	3-7/8"	3"
07	4-5/8"	
08	5-3/8"	4-5/8"
09	6-1/4"	
10	7"	6-1/4"
11	7-3/4"	
12	8-1/2"	
13	9-3/8"	
14	10-1/8"	
15	10-7/8"	
16	11-3/4"	
17	12-1/2"	
18	13-1/4"	

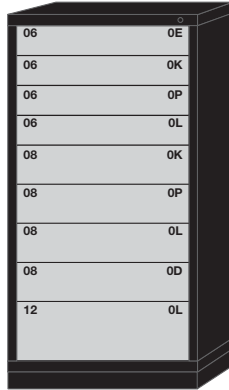

9 drawers with 140 compartments

6830301012

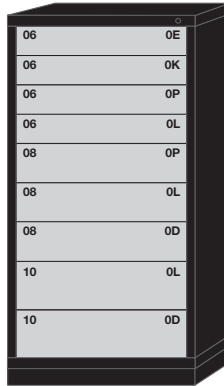

9 drawers with 128 compartments

6830301029

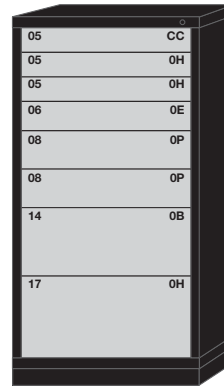

8 drawers with 184 compartments

68303000D

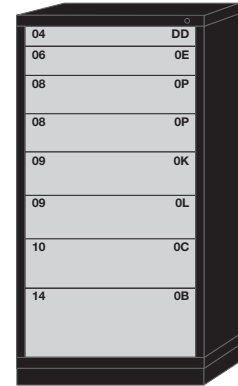

8 drawers with 181 compartments

683030000E

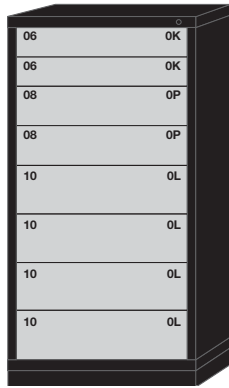

8 drawers with 120 compartments

6830301031

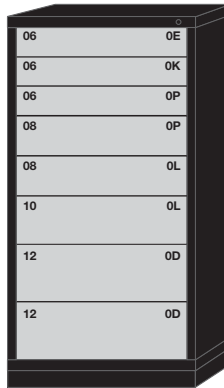

8 drawers with 116 compartments

683030303

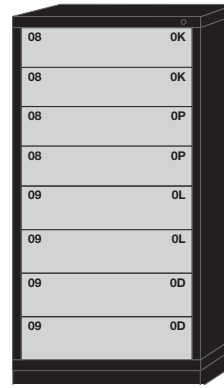

8 drawers with 112 compartments

6830301030

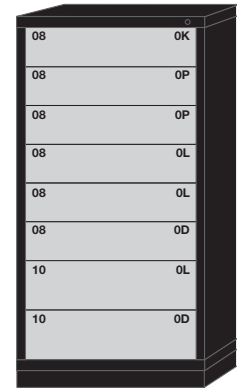

8 drawers with 104 compartments

6830301014

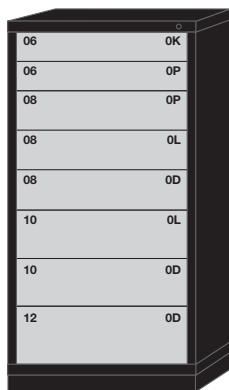

8 drawers with 100 compartments

6830301032

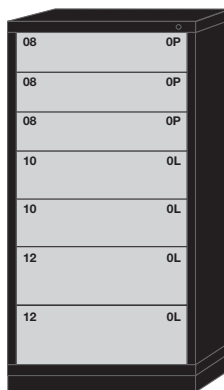

7 drawers with 96 compartments

6830301034

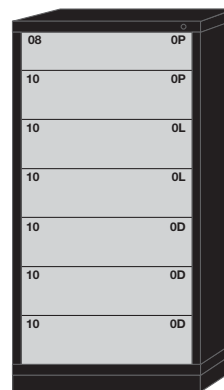

7 drawers with 80 compartments

6830301015

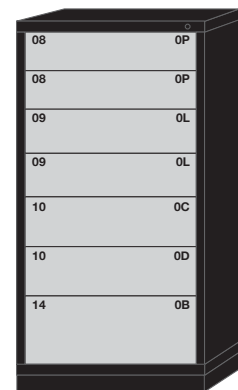

7 drawers with 77 compartments

683030000G

MDC

Modular Drawer Cabinets

All Pre-Engineered Modular Drawer 30" Wide Standard Cabinets on this page feature:

- Fork Lift Base

Compartment quantities under each cabinet is based on choosing the layout kit option as noted in step 4 on page 2. Standard cabinet layout kits can be found pages 12 and 13.

EYE-LEVEL – 59-1/4" H x 28-1/4" D

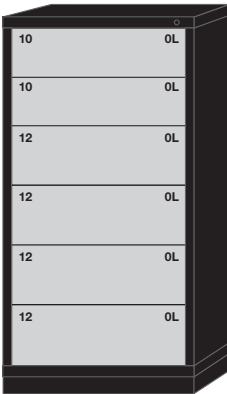

6 drawers with 72 compartments
■ ■ **6830301035** ■

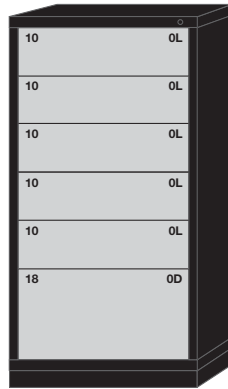

6 drawers with 68 compartments
■ ■ ■ **6830301037** ■

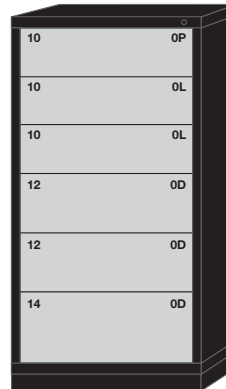

6 drawers with 64 compartments
■ ■ ■ **6830301036** ■

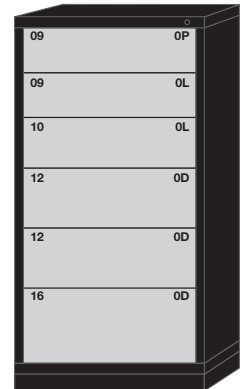

6 drawers with 64 compartments
■ ■ ■ **6830301016** ■

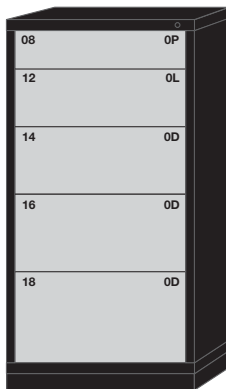

5 drawers with 52 compartments
■ ■ ■ **6830301038** ■

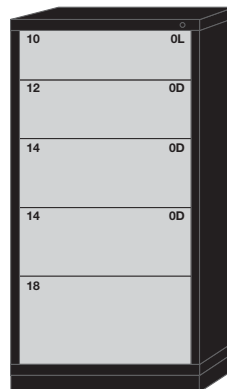

5 drawers with 37 compartments
■ ■ ■ **6830301017** ■

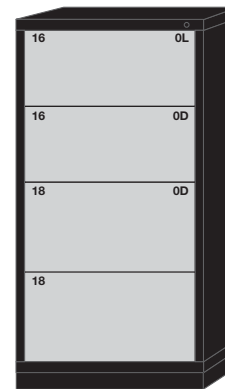

4 drawers with 29 compartments
■ ■ ■ **6830301018** ■

Drawer Number	04	05	06	07	08	09	10	11	12	13	14	15	16	17	18
Usable Height	2-1/4"	3"	3-7/8"	4-5/8"	5-3/8"	6-1/4"	7"	7-3/4"	8-1/2"	9-3/8"	10-1/8"	10-7/8"	11-3/4"	12-1/2"	13-1/4"
Side Height	1-7/8"		3"		4-3/8"			6-1/4"							



MDC

Modular Drawer Cabinets

Standard Width
Layout Kits

How to Order:

Complete the part number with one of the following drawer numbers:

- 045** for 04 & 05
- 067** for 06 & 07
- 089** for 08 & 09
- 100** for 10+

Example:

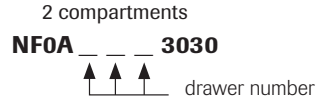
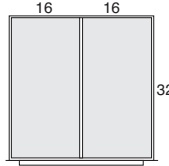

The prefix NF has been added to each Layout Kit part number

The catalog number for the pre-engineered layout kit for a 04 and 05 drawer number with 2 compartments is:

NFOA0453030

Usable Height

Use the chart below to identify "Usable Height" dimensions for the specific drawer numbers.

Drawer Number	04	05	06	07	08	09	10	11	12	13	14	15	16	17	18
Usable Height	2-1/4"	3"	3-7/8"	4-5/8"	5-3/8"	6-1/4"	7"	7-3/4"	8-1/2"	9-3/8"	10-1/8"	10-7/8"	11-3/4"	12-1/2"	13-1/4"
Side Height	1-7/8"		3"		4-3/8"			6-1/4"							

Compartment Size

The chart below identifies individual compartment sizes found in the layout kit illustrations.

Compartment Size	3	4	5	6	7	8	9	10	11	12	13	14	15	16	17
Dimension	1-7/8"	2-11/16"	3-1/2"	4-1/4"	5-1/16"	5-7/8"	6-11/16"	7-1/2"	8-1/4"	9-1/16"	9-7/8"	10-11/16"	11-1/2"	12-1/4"	13-1/16"
Compartment Size	18	19	20	21	22	23	24	25	26	27	28	29	30	31	32
Dimension	13-7/8"	14-11/16"	15-1/2"	16-1/4"	17-1/16"	17-7/8"	18-11/16"	19-1/2"	20-1/4"	21-1/16"	21-7/8"	22-11/16"	23-7/16"	24-1/4"	25-1/16"

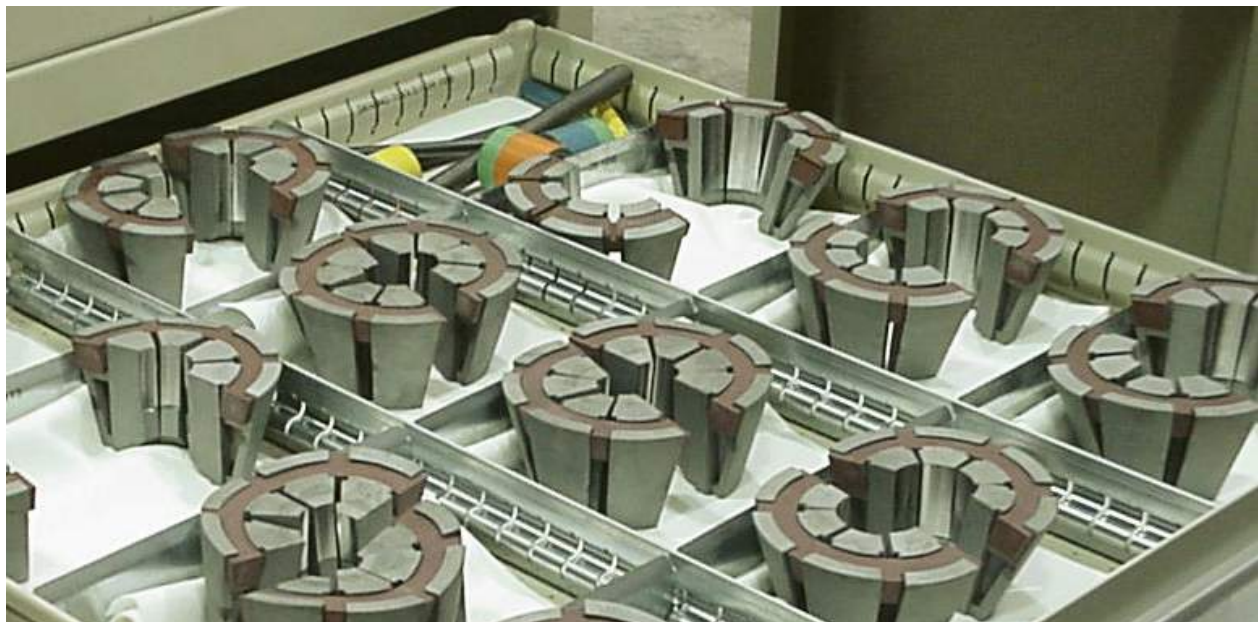

OVERHEAD UNITS

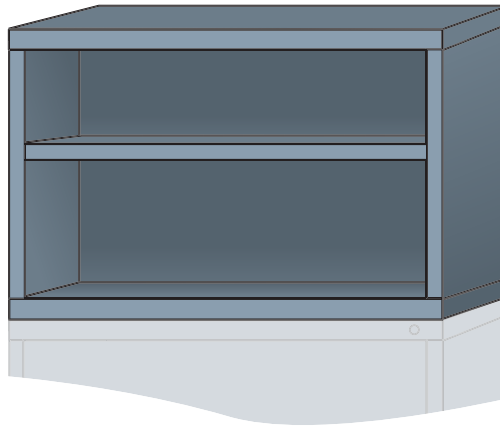
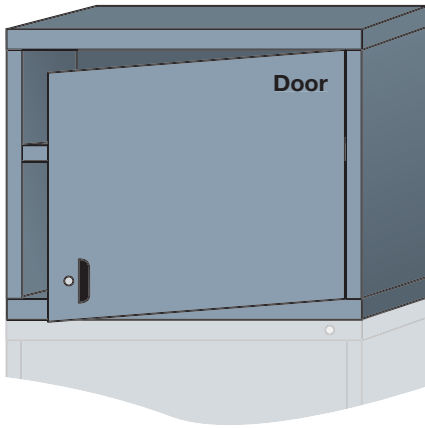

- Provides additional bulk storage above cabinets
- Flat bottom attaches directly to cabinet top below (no drilling—fasteners supplied)
- Door locks are keyed-alike to cabinet below if ordered together
- Shipped pre-assembled to lower cabinet if ordered together
- *Specify color (add the two (2) letter digit as a prefix to the part number from step 1 on page 40)*
- *Determine locking system. Use either; N for No locking system, L for standard locking system. Add the locking system digit as a suffix to the part number*

	Slender (22-13/16" Wide)	Standard (30" Wide)	Medium (36-3/8" Wide)
24-7/8" Height	Base shelf and adjustable shelf without base channels ■ ■ N27223010500N	Base shelf and adjustable shelf without base channels ■ ■ N27303010500N	Base shelf and adjustable shelf without base channels ■ ■ N27363010500N
28" Height	Base shelf and adjustable shelf behind lockable swing door without base channels ■ ■ N27223010550_	Base shelf and adjustable shelf behind lockable swing door without base channels ■ ■ N27303010550_	Base shelf and adjustable shelf behind lockable swing door without base channels ■ ■ N27363010550_
31-1/8" Height	Base shelf and adjustable shelf without base channels ■ ■ N31223010500N	Base shelf and adjustable shelf without base channels ■ ■ N31303010500N	Base shelf and adjustable shelf without base channels ■ ■ N31363010500N
	Base shelf and adjustable shelf behind lockable swing door without base channels ■ ■ N31223010550_	Base shelf and adjustable shelf behind lockable swing door without base channels ■ ■ N31303010550_	Base shelf and adjustable shelf behind lockable swing door without base channels ■ ■ N31363010550_
	Base shelf and adjustable shelf without base channels ■ ■ N35223010500N	Base shelf and adjustable shelf without base channels ■ ■ N35303010500N	Base shelf and adjustable shelf without base channels ■ ■ N35363010500N
	Base shelf and adjustable shelf behind lockable swing door without base channels ■ ■ N35223010550_	Base shelf and adjustable shelf behind lockable swing door without base channels ■ ■ N35303010550_	Base shelf and adjustable shelf behind lockable swing door without base channels ■ ■ N35363010550_

For additional heights, Contact Customer Service at 1-800-323-0082



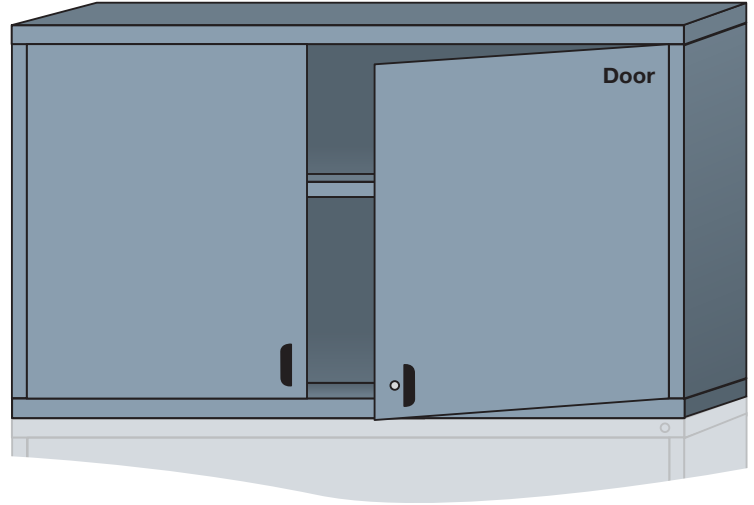
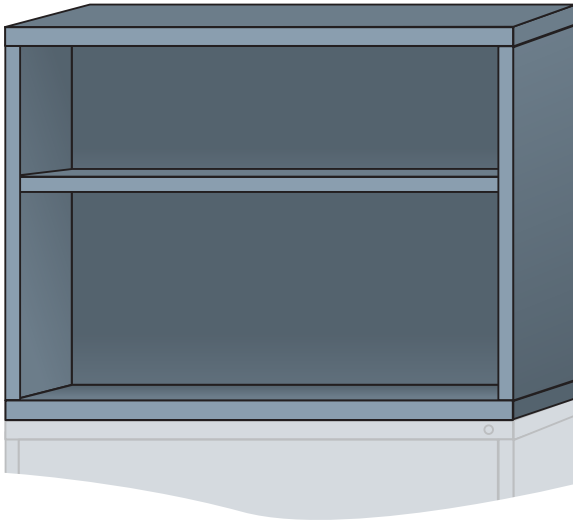

Extra

(44-3/8" Wide)

Base shelf and adjustable shelf without base channels

■ ■ **N27453010500N**

Base shelf and adjustable shelf behind lockable swing doors without base channels

■ ■ **N27453010550_**

Double

(59-5/8" Wide)

Base shelf and adjustable shelf without base channels

■ ■ **N27603010500N**

Base shelf and adjustable shelf behind lockable swing doors without base channels

■ ■ **N27603010550_**

Base shelf and adjustable shelf without base channels

■ ■ **N31453010500N**

Base shelf and adjustable shelf behind lockable swing doors without base channels

■ ■ **N31453010550_**

Base shelf and adjustable shelf without base channels

■ ■ **N31603010500N**

Base shelf and adjustable shelf behind lockable swing doors without base channels

■ ■ **N31603010550_**

Base shelf and adjustable shelf without base channels

■ ■ **N35453010500N**

Base shelf and adjustable shelf behind lockable swing door without base channels

■ ■ **N35453010550_**

Base shelf and adjustable shelf without base channels

■ ■ **N35603010500N**

Base shelf and adjustable shelf behind lockable swing door without base channels

■ ■ **N36603010550_**

24-7/8"
Height

28"
Height

31-1/8"
Height

EXAMPLE

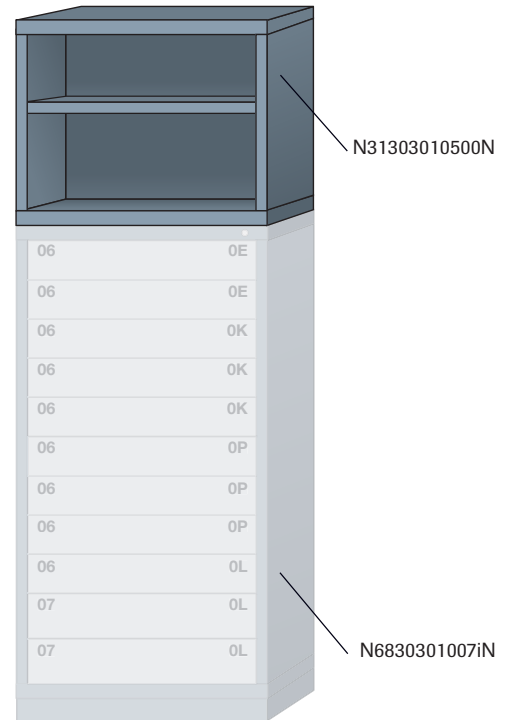

Note: Overhead cabinet width must match width of lower cabinet; exception, Double overhead cabinets at 59-5/8" wide can be assembled over two (2) standard cabinets which are 30" wide, keep in mind this installation will produce a 3/8" gap on either side of the overhead unit. Field installation only.



Mobile cabinets provide a workshop on wheels.

- Includes tubular handle and rubber end caps
- Includes (2) fixed and (2) swivel with brake, 6" dia. x 2" w casters (2,800 lb. capacity)
- Drawer units feature single drawer access
- Polyolefin caster tread does not mar floors
- Cabinet ships pre-assembled. Assembly required for casters and handle
- Drawer layout kits include black polyester mesh insert

Drawer Number	04	05	06	07	08	09	10	11	12	13	14	15	16	17	18
Usable Height	2-1/4"	3"	3-7/8"	4-5/8"	5-3/8"	6-1/4"	7"	7-3/4"	8-1/2"	9-3/8"	10-1/8"	10-7/8"	11-3/4"	12-1/2"	13-1/4"
Side Height	1-7/8"		3"		4-3/8"			6-1/4"							

Standard (30" Wide)

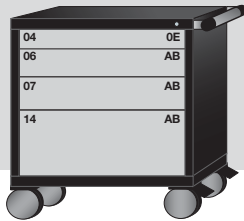

4 drawers with 21 compartments overall height = 35-1/2"

■ ■ **S3130301009** ■ ■

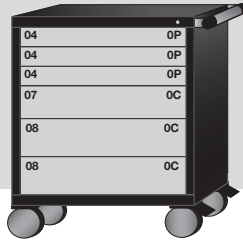

6 drawers with 75 compartments overall height = 38-5/8"

■ ■ **S3530301019** ■ ■

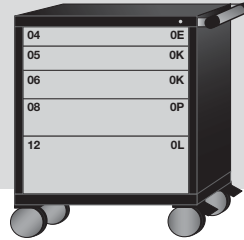

5 drawers with 92 compartments overall height = 38-5/8"

■ ■ **S3530301020** ■ ■

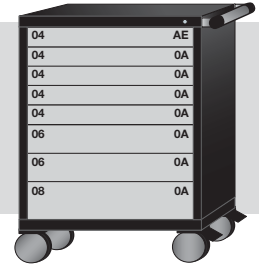

8 drawers with 24 compartments overall height = 42-9/16"

■ ■ **S4030301020** ■ ■

Medium (36-3/8" Wide)



6 drawers with 108 compartments overall height = 38-5/8"

■ ■ **S3536301021** ■ ■



5 drawers with 104 compartments overall height = 38-5/8"

■ ■ **S3536301022** ■ ■



5 drawers with 84 compartments overall height = 42-9/16"

■ ■ **S4036301021** ■ ■

Extra (44-3/8" Wide)

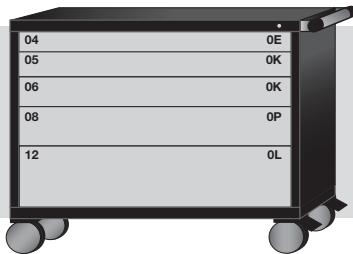

5 drawers with 92 compartments overall height = 38-5/8"

■ ■ **S3545301020** ■ ■

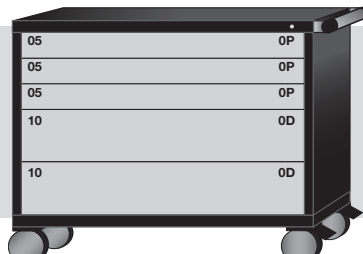

5 drawers with 64 compartments overall height = 38-5/8"

■ ■ **S3545301023** ■ ■



8 drawers with 44 compartments overall height = 42-9/16"

■ ■ **S4045301020** ■ ■

Side-by-side cabinets provide a workshop on wheels.

- Includes tubular handle and rubber end caps
- Includes (2) fixed and (2) swivel w/brake, 6" dia. x 2"w casters (2,800 lb. capacity)
- Polyolefin caster tread does not mar floors
- Drawer units feature single drawer access
- Cabinet and door locks are keyed-alike
- Cabinet ships pre-assembled. Assembly required for casters and handle
- Drawer layout kits include black polyester mesh insert

Drawer Number	04	05	06	07	08	09	10	11	12	13	14	15	16	17	18
Usable Height	2-1/4"	3"	3-7/8"	4-5/8"	5-3/8"	6-1/4"	7"	7-3/4"	8-1/2"	9-3/8"	10-1/8"	10-7/8"	11-3/4"	12-1/2"	13-1/4"
Side Height	1-7/8"		3"		4-3/8"			6-1/4"							

Bench
(39-3/4" High)



6 drawers with 108 compartments
base shelf and adjustable shelf behind lockable swing door
■ **S352230W1001** ■ - 45-5/8"w
■ **S353030W2001** ■ - 60"w



5 drawers with 104 compartments
base shelf and adjustable shelf behind lockable swing door
■ **S352230W1002** ■ - 45-5/8"w
■ **S353030W2002** ■ - 60"w



4 drawers with 21 compartments
base shelf and adjustable shelf behind lockable swing door
■ **S352230W1003** ■ - 45-5/8"w
■ **S353030W2003** ■ - 60"w

Bench
(39-3/4" High)

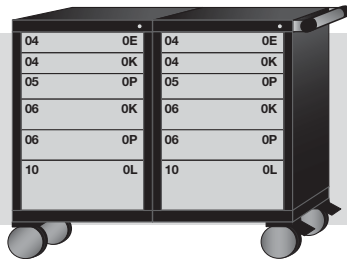

12 drawers with 216 compartments
■ **S352230W1004** ■ - 45-5/8"w
■ **S353030W2004** ■ - 60"w

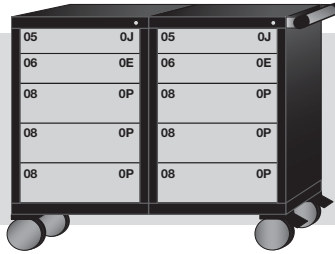

10 drawers with 208 compartments
■ **S352230W1005** ■ - 45-5/8"w
■ **S353030W2005** ■ - 60"w



8 drawers with 42 compartments
■ **S352230W1006** ■ - 45-5/8"w
■ **S353030W2006** ■ - 60"w

Mid-Range
(43-3/4" High)



6 drawers with 58 compartments
base shelf and adjustable shelf behind lockable swing door
■ **S402230W1001** ■ - 45-5/8"w
■ **S403030W2001** ■ - 60"w



5 drawers with 60 compartments
base shelf and adjustable shelf behind lockable swing door
■ **S402230W1002** ■ - 45-5/8"w
■ **S403030W2002** ■ - 60"w



4 drawers with 96 compartments
2 base shelves and 2 adjustable shelves behind 2 lockable swing doors
■ **S402230W1003** ■ - 45-5/8"w
■ **S403030W2003** ■ - 60"w



Pre-Engineered Modular Drawers in Shelving

Shelving System is 30"w x 30"d x 84"h

- Pre-engineered units can be used as stand-alone starter units or assemble them in rows with add-on units
- Drawers feature capacity of 400 lbs. and fully extend for visual and physical access (*same drawers used in Standard, 30"w Cabinets*)
- Add drawer layout kits to increase storage density within each drawer (*same layout kits used in Standard, 30"w Cabinets—see pages 12-13*)
- Shelves feature capacity of 800 lbs. and are adjustable on 1-1/2" centers
- Shipped knocked-down for field assembly only

Step 1

Select Shelving Color –
Enter **LETTER** designation

Step 2

Select Drawer Color –
Enter **LETTER** designation

Shelving Colors

D
Dove Gray

P
Putty

B
Wedgewood Blue

Drawer Number	04	05	06	07	08	09	10	11	12	13	14	15	16	17	18
Usable Height	2-1/4"	3"	3-7/8"	4-5/8"	5-3/8"	6-1/4"	7"	7-3/4"	8-1/2"	9-3/8"	10-1/8"	10-7/8"	11-3/4"	12-1/2"	13-1/4"
Side Height	1-7/8"		3"		4-3/8"			6-1/4"							

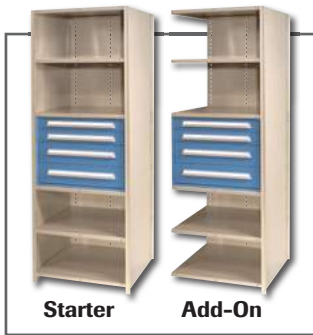

Starter **Add-On**

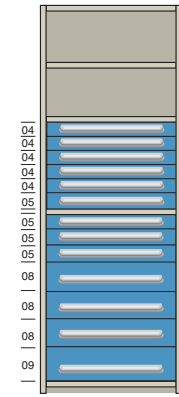

13 drawers, 5 shelves,
(1) 18 & 36" support frame

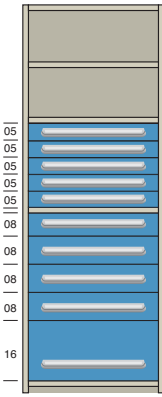

10 drawers, 5 shelves,
(1) 18 & 36" support frame

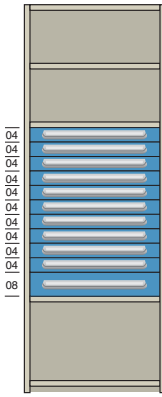

11 drawers, 5 shelves,
(1) 36" support frame

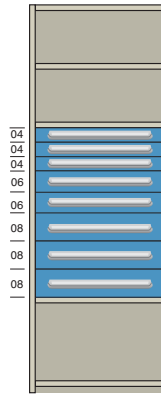

8 drawers, 5 shelves,
(1) 36" support frame

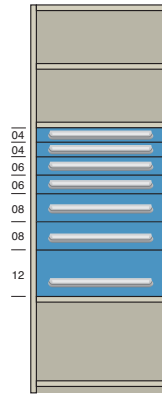

7 drawers, 5 shelves,
(1) 36" support frame

Starter	■ ■ 86014SH	■ ■ 86016SH	■ ■ 86006SH	■ ■ 86010SH	■ ■ 86008SH
Add-on	■ ■ 86014H	■ ■ 86016H	■ ■ 86006H	■ ■ 86010H	■ ■ 86008H

Drawer Colors

B
Wedgewood Blue

D
Dove Gray

P
Putty

H
Red Baron

J
Hunter Green

K
Vulcan Black

A
Ash

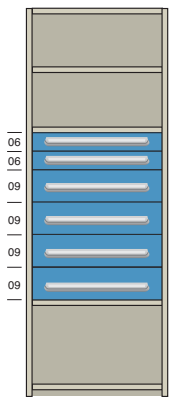

6 drawers, 5 shelves,
(1) 36" support frame

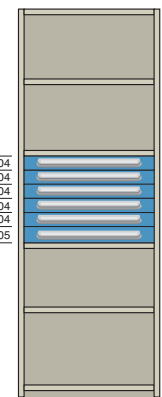

6 drawers, 6 shelves,
(1) 18" support frame

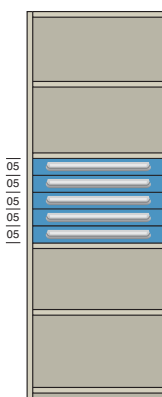

5 drawers, 6 shelves,
(1) 18" support frame

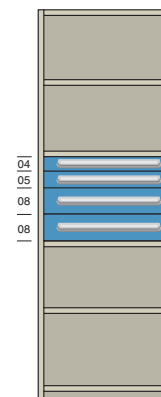

4 drawers, 6 shelves,
(1) 18" support frame

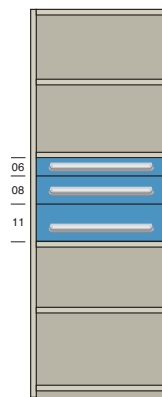

3 drawers, 6 shelves,
(1) 18" support frame

Starter	■ ■ 86012SH	■ ■ 86004SH	■ ■ 86000SH	■ ■ 86002SH	■ ■ 86005SH
Add-on	■ ■ 86012H	■ ■ 86004H	■ ■ 86000H	■ ■ 86002H	■ ■ 86005H

**Custom Design
Modular Drawers
in Shelving Units**

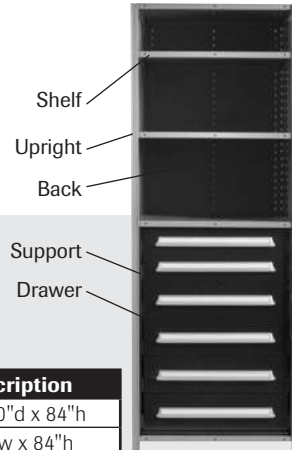

Example

**Shelving System is
30"w x 30"d x 84"h**

Qty.	Cat. No.	Description
2	DD8886	Upright 30"d x 84"h
1	DD86481	Back, 30"w x 84"h
5	DD8593H1	Shelf, 30"w x 30"d
1	KKN483030DGS	Support, 36"h
2	KKN063030NN000	Drawer, 3-7/8" usable
4	KKN093030NN000	Drawer, 6-1/4" usable

Step 1 - Shelving Selection

Select shelving.

Cat. No.	Description
FRAME WORK	
8886	Upright Assembly (2 required per starter section)*
86481	Shelving Back (1 required per section)
SHELVES	
8593H1	Shelf 30"w x 30"d (minimum 4 per section required)

*Note: Shelves are required immediately above and below drawer guide support. *Only 1 required per add-on selection.*

Step 2 - Shelving Color Selection

Determine your color, then add the two (2) letter digits as a **prefix** to the shelving catalog numbers chosen in step 1.



Step 3 - Support Selection

Select the drawer guide support(s), depending on whether you want a short stack of drawers (18" High) or a tall stack (36" High) or a combination.

DRAWER GUIDE SUPPORTS	
Cat. No.	Description
N253030DGS	Drawer Guide Support, 18"h
N483030DGS	Drawer Guide Support, 36"h

Step 4 - Drawer Selection

Select the number of drawers desired. (see example).

MODULAR DRAWERS FOR 30"W SHELVING		
Cat. No.	Front Height	Usable Height
N043030NN000	3-1/16"	2-1/4"
N053030NN000	3-7/8"	3"
N063030NN000	4-5/16"	3-7/8"
N073030NN000	5-7/16"	4-5/8"
N083030NN000	6-3/16"	5-3/8"
N093030NN000	7"	6-1/4"
N103030NN000	7-3/4"	7"
N113030NN000	8-9/16"	7-3/4"
N123030NN000	9-3/8"	8-1/2"
N133030NN000	10-1/4"	9-3/8"
N143030NN000	10-7/8"	10-1/8"
N153030NN000	11-3/4"	10-7/8"
N163030NN000	12-1/2"	11-3/4"
N173030NN000	13-15/16"	12-1/2"
N183030NN000	14-1/16"	13-1/4"
NRS3030NN000	3-7/8"	3"

Example

When selecting drawer configurations you must add the drawer numbers to equal the first 2 numbers of the *Drawer Guide Support*.

Drawer Guide Support
No. **N253030DGS**

(3) No. **N043030NN00**
drawers = 12

(1) No. **N063030NN00**
drawer = 06

(1) No. **N073030NN00**
drawer = 07

Total = 25

Step 5 - Support/Drawer Color Selection

Determine your color, then add the two (2) letter digits as a prefix to the catalog numbers chosen.



Step 6 - Layout Selection (optional)

Determine your drawer layouts from pages 12-13, then choose the catalog number specific to the drawer size. Layouts are shipped unassembled.

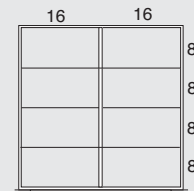

Work Bench Kit Style 1

- Kit includes panel leg, adjustable footrest, and work surface
- All work surfaces are 30" deep
- Kit can be assembled to either side of cabinet
- Field installed only

Step 1 - Modular Drawer Cabinets

Choose one of the pre-engineered cabinets from our Desk High, Table High, Bench High or Mid-Range High selections on pages 3, 4, 5, or 6 of this catalog in Standard widths. For slender widths contact customer service.

Note: Consider cabinets with (Multiple Drawer Access), since tipping is highly unlikely.

Step 2 - Work Bench Kit

Match the cabinet to the cabinet height of the kits in the table to the right. Choose the work surface for your work bench. *Note: The part number chosen in Step 1 combined with the part number chosen in Step 2, creates a Work Bench.*

Laminate = Particle board core with plastic laminate cover.



- Ideal for light-duty applications
- 180° soft edge, chip resistant
- Color = Putty
- 1-5/8" Thick
- 800 lb. capacity

Steel = 12 Gauge formed panel with reinforcing channels.



- Ideal for heavy-duty applications
- 1-3/4" Thick
- 1,700 lb. capacity

Laminated Wood = Solid-laminated with rounded edges and sealed finish.



- Ideal for precision work
- Sealed Kiln-dried hardwoods
- 3/16" radius edges
- 1-3/4" Thick
- 5,000 lb. capacity

Stainless = 16 Gauge formed stainless steel cover over hardwood.



- For the ultimate work bench application
- 1-13/16" Thick
- 5,000 lb. capacity

Custom lengths available on special request.

Please note: catalog numbers do not include cabinet. (see step 1).

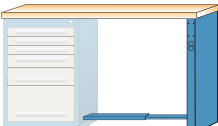
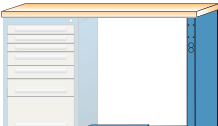
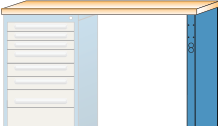
Work Surface Height	Cat. No.	Work Surface	
Desk (28-5/8" High) 	■ 251270WB1001	60"w Laminate	
	■ 251270WB1003	60"w Steel	
	■ 251270WB1004	60"w Hardwood	
	■ 251270WB1005	60"w Stainless	
	■ 251270WB1011	72"w Laminate	
	■ 251270WB1013	72"w Steel	
	■ 251270WB1014	72"w Hardwood	
	■ 251270WB1015	72"w Stainless	
	Table (31-7/8" High) 	■ 251310WB1001	60"w Laminate
		■ 251310WB1003	60"w Steel
■ 251310WB1004		60"w Hardwood	
■ 251310WB1005		60"w Stainless	
■ 251310WB1011		72"w Laminate	
■ 251310WB1013		72"w Steel	
■ 251310WB1014		72"w Hardwood	
■ 251310WB1015		72"w Stainless	
Bench (35" High) 		■ 251350WB1001	60"w Laminate
		■ 251350WB1003	60"w Steel
	■ 251350WB1004	60"w Hardwood	
	■ 251350WB1005	60"w Stainless	
	■ 251350WB1011	72"w Laminate	
	■ 251350WB1013	72"w Steel	
	■ 251350WB1014	72"w Hardwood	
	■ 251350WB1015	72"w Stainless	
	Mid-Range (39" High) 	■ 251400WB1001	60"w Laminate
		■ 251400WB1003	60"w Steel
■ 251400WB1004		60"w Hardwood	
■ 251400WB1005		60"w Stainless	
■ 251400WB1011		72"w Laminate	
■ 251400WB1013		72"w Steel	
■ 251400WB1014		72"w Hardwood	
■ 251400WB1015		72"w Stainless	

Color Selection

Determine which color you desire and add the two (2) letter ■ digits as a prefix to the Work Bench chosen.



Work Bench Kit Style 2

- Kit includes panel leg, adjustable footrest, steel shelf riser (12" h x 10-1/2" d), back stop, pick rack, and work surface
- All work surfaces are 30" deep
- Kit can be assembled to either side of cabinet
- Field installed only

Step 1 - Modular Drawer Cabinets

Choose one of the pre-engineered cabinets from our Desk High, Table High, Bench High or Mid-Range High selections on pages 3, 4, 5, or 6 of this catalog in Standard widths. For slender widths contact customer service.

Note: Consider cabinets with (Multiple Drawer Access), since tipping is highly unlikely.

Step 2 - Work Bench Kit

Match the cabinet to the cabinet height of the kits in the table to the right. Choose the work surface for your work bench. *Note: The part number chosen in Step 1 combined with the part number chosen in Step 2, creates a Work Bench.*

Laminate = Particle board core with plastic laminate cover.



- Ideal for light-duty applications
- 180° soft edge, chip resistant
- Color = Putty
- 1-5/8" Thick
- 800 lb. capacity

Steel = 12 Gauge formed panel with reinforcing channels.

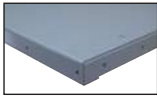

- Ideal for heavy-duty applications
- 1-3/4" Thick
- 1,700 lb. capacity

Laminated Wood = Solid-laminated with rounded edges and sealed finish.



- Ideal for precision work
- Sealed Kiln-dried hardwoods
- 3/16" radius edges
- 1-3/4" Thick
- 5,000 lb. capacity

Stainless = 16 Gauge formed stainless steel cover over hardwood.



- For the ultimate work bench application
- 1-13/16" Thick
- 5,000 lb. capacity

Custom lengths available on special request.

Please note: catalog numbers do not include cabinet. (see step 1).

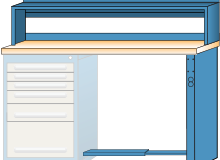
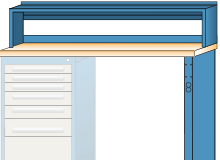
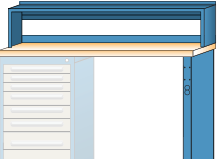
Work Surface Height	Cat. No.	Work Surface
Desk (28-5/8" High) 	■ 251270WB1006	60"w Laminate
	■ 251270WB1008	60"w Steel
	■ 251270WB1009	60"w Hardwood
	■ 251270WB1010	60"w Stainless
	■ 251270WB1016	72"w Laminate
	■ 251270WB1018	72"w Steel
	■ 251270WB1019	72"w Hardwood
	■ 251270WB1020	72"w Stainless
Table (31-7/8" High) 	■ 251310WB1006	60"w Laminate
	■ 251310WB1008	60"w Steel
	■ 251310WB1009	60"w Hardwood
	■ 251310WB1010	60"w Stainless
	■ 251310WB1016	72"w Laminate
	■ 251310WB1018	72"w Steel
	■ 251310WB1019	72"w Hardwood
	■ 251310WB1020	72"w Stainless
Bench (35" High) 	■ 251350WB1006	60"w Laminate
	■ 251350WB1008	60"w Steel
	■ 251350WB1009	60"w Hardwood
	■ 251350WB1010	60"w Stainless
	■ 251350WB1016	72"w Laminate
	■ 251350WB1018	72"w Steel
	■ 251350WB1019	72"w Hardwood
	■ 251350WB1020	72"w Stainless
Mid-Range (39" High) 	■ 251400WB1006	60"w Laminate
	■ 251400WB1008	60"w Steel
	■ 251400WB1009	60"w Hardwood
	■ 251400WB1010	60"w Stainless
	■ 251400WB1016	72"w Laminate
	■ 251400WB1018	72"w Steel
	■ 251400WB1019	72"w Hardwood
	■ 251400WB1020	72"w Stainless

Color Selection

Determine which color you desire and add the two (2) letter ■ digits as a prefix to the Work Bench chosen.



(A) Modular Drawer Cabinets

Choose from any Standard Pre-Engineered Cabinet (pages 3-11) or create your own custom cabinet by contacting customer service at 800-323-0082.

Note: Consider cabinets with (Multiple Drawer Access or no lock), since tipping is highly unlikely.

(B) Panel Legs

- One-piece, heavy-gauge welded frame pre-punched for ease of assembly
- Supplied with knock-outs for customer supplied electrical outlet
- Supplied with leg levelers and mounting hardware to compensate for uneven floors
- Match panel leg height to cabinet height chosen

Specify color

Open Panel Leg (for industrial applications)

No. ■ **251OPL270** - Desk, 26-7/8"H

No. ■ **251OPL310** - Table, 30-1/8"H

No. ■ **251OPL350** - Bench, 33-1/4"H

No. ■ **251OPL400** - Mid-Range, 37-3/16"H

Closed Panel Leg (for office applications)

No. ■ **251CPL270** - Desk, 26-7/8"H

No. ■ **251CPL310** - Table, 30-1/8"H

No. ■ **251CPL350** - Bench, 33-1/4"H

No. ■ **251CPL400** - Midrange, 37-3/16"H

(C) Side Stops

- Extends 3" above work surface to help small parts from rolling off
- Front tapered to 1-1/2" above work surface with rounded front edge
- Includes mounting fasteners

Specify color

No. ■ **251WSSR** - Right Side

No. ■ **251WSSL** - Left Side

(D) Back Stops

- Extends 3" above work surface to help small parts from rolling off
- Match the length of the Back Stop to the width of the work surface
- Includes mounting fasteners

Specify color

No. ■ **251WBS60** - 60"w

No. ■ **251WBS84** - 84"w

No. ■ **251WBS72** - 72"w

No. ■ **251WBS90** - 90"w

(E) Shelf Risers

- Easy to reach shelf storage above work surface
- Match the width of the Shelf Riser to the work surface width

Specify color

60"w Work Surface

72"w Work Surface

No. ■ **2625** - 12"h x 10-1/2"d

No. ■ **2626** - 12"h x 10-1/2"d

No. ■ **2628** - 18"h x 14"d

No. ■ **2629** - 18"h x 14"d

(F) Pick Racks

- Allows easy hanging of plastic bins for additional on-hand storage
- Easy attachment to back of Shelf Risers
- Match the width of the Pick Rack to the Shelf Riser width

Specify color

No. ■ **2630** - 60"w

No. ■ **2631** - 72"w



(G) Plastic Bins (imported item)

- Allows for moveable storage of small parts from the work area
- Impervious to most solvents and corrosives
- Color=Blue only

No. **78203** - 4-1/8"w x 4-1/8"d x 3"h

No. **78206** - 4-1/8"w x 7-1/4"d x 3"h

No. **78209** - 5-7/8"w x 11-1/2"d x 5"h

(H) Stringers

- Economic alternative to adjustable Footrest
- Formed steel channel attaches panel leg to cabinet with mounting hardware supplied

Specify color

60"w Work Surface

No. ■ **251STR60SL** - 33-1/4"L used with Slender Cabinet

No. ■ **251STR60** - 26-1/16"L used with Standard Cabinet

No. ■ **251STR60WB** - 60" stringer to be used with two panel legs

72"w Work Surface

No. ■ **251STR72SL** - 45-1/4"L used with Slender Cabinet

No. ■ **251STR72** - 38-1/16"L used with Standard Cabinet

No. ■ **251STR36** - 20-5/8"L used with Slender Cabinet

No. ■ **251STR72WB** - 72" stringer to be used with two panel legs

(I) Work Bench Shelves (not shown above)

- Allows Lyon panel legs to be used as a workbench

Specify color

60"w Work Surface

No. ■ **251UCSD60S1** - 60" shelf to be used with two panel legs

72"w Work Surface

No. ■ **251UCSD72S1** - 72" shelf to be used with two panel legs

Color Selection

Determine the color and add the two letter ■ digits as a prefix to catalog numbers.

AA

Ash

BB

Wedgewood Blue

DD

Dove Gray

HH

Red Baron

JJ

Hunter Green

KK

Vulcan Black

PP

Putty

Work Surfaces

Available in Laminate, Steel, Hardwood, or Stainless Cover over Industrial Grade Particle Board (ISPB). Custom lengths for all work surfaces are available on special request.

Laminate (WLT) = Particle board core with plastic laminate cover.



- Ideal for light-duty applications
- 180° soft edge, chip resistant
- Color = Putty or Dove Gray Only. *Specify color*

No. ■ **251WLT60** - 30"d x 1-5/8"t x 60"w

No. ■ **251WLT72** - 30"d x 1-5/8"t x 72"w

Steel (WSL) = 12 Gauge formed panel with reinforcing channels.

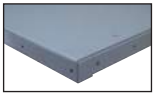

- Ideal for heavy-duty maintenance work
- *Specify color*

No. ■ **251WSL60** - 30"d x 1-3/4"t x 60"w

No. ■ **251WSL72** - 30"d x 1-3/4"t x 72"w

Stainless (WST) = 16-Gauge type 304, #4 finish formed stainless steel cover over Industrial Grade Particle Board (ISPB).

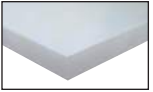

- For the ultimate work bench application
- Edges are wrapped and welded

No. ■ **251WST60** - 30"d x 1-5/8"t x 60"w

No. ■ **251WST72** - 30"d x 1-5/8"t x 72"w

Laminated Wood (WHD) = Solid-laminated with rounded edges and sealed finish.



- Ideal for precision work
- Sealed Kiln-dried hardwoods
- 3/16" radius edges

No. ■ **251WHD60** - 30"d x 1-3/4"t x 60"w

No. ■ **251WHD72** - 30"d x 1-3/4"t x 72"w

No. ■ **251WHD84** - 30"d x 1-3/4"t x 84"w

No. ■ **251WHD90** - 30"d x 1-3/4"t x 90"w

No. ■ **251WHD96** - 30"d x 1-3/4"t x 96"w

No. ■ **251WHD120** - 30"d x 1-3/4"t x 120"w

Color Selection

Determine the color and add the two letter ■ digits as a prefix to catalog numbers.



Ash



Wedgewood Blue



Dove Gray



Red Baron



Hunter Green



Vulcan Black



Putty



Outlet Strip

- Easily attaches to any flanged surface
- UL approved for 15 AMPS @ 125V
- Match the length of the Outlet Strip to the work surface width
- Color = Light Gray only

No. **2662** - 5 outlets - 60"w

No. **2663** - 8 outlets - 72" w

Adjustable Footrest

- Multi-formed, reinforced steel channels pre-punched for assembly
- Sleeved and adjustable for many length combinations

Specify color

No. ■ **240853** - 27" to 46-1/4"

No. ■ **240854** - 46-1/4" to 69"

No. ■ **240855** - 18" to 29"



Hi-Lo Bracket Kit

- Allows for mounting work surface directly to the side of a cabinet
- Includes mounting fasteners
- Galvanized finish

No. **250HILO**



Splice Plate Kit

- Allows for attaching two (2) worksurfaces into a corner, creating an "L"
- Includes mounting fasteners
- Galvanized finish

No. **250SPLICE**



(J) Bookcase Risers

- Maintains work surface area while providing additional storage space above
- Designed to support the weight of up to three, loaded Bookcases
- Attaches to Work Surface with supplied hardware
- Corner Riser used to join two adjacent ends (includes Back Panel)
- Hardware supplied to support the optional **No. 79020** Light Fixture

Specify color ■ - two digit color code

Bookcase Riser

- No. ■ 251BRS6018** - 60" w x 14" d x 18" h
- No. ■ 251BRS6021** - 60" w x 14" d x 21" h
- No. ■ 251BRS6024** - 60" w x 14" d x 24" h
- No. ■ 251BRS7218** - 72" w x 14" d x 18" h
- No. ■ 251BRS7221** - 72" w x 14" d x 21" h
- No. ■ 251BRS7224** - 72" w x 14" d x 24" h
- No. ■ 251BRS9018** - 90" w x 14" d x 18" h
- No. ■ 251BRS9021** - 90" w x 14" d x 21" h
- No. ■ 251BRS9024** - 90" w x 14" d x 24" h

Bookcase Corner Riser

- No. ■ 251BCR3018** - 90" w x 14" d x 18" h
- No. ■ 251BCR3021** - 90" w x 14" d x 21" h
- No. ■ 251BCR3024** - 90" w x 14" d x 24" h

(K) Bookcases

- Similar construction to an MDC "Housing"
- One bottom shelf and one adjustable shelf included with 100 lb. capacity each
- Overhead storage unit attaches to Riser with supplied hardware
- Can be wall-mounted, hardware not included

Specify color ■ - two digit color code

30"W without lockable swing doors

- No. ■ 251BKC270** - 30" w x 14" d x 24-3/4" h
- No. ■ 251BKC350** - 30" w x 14" d x 31-1/8" h

30"W with lockable swing doors

- No. ■ 251BKCD270** - 30" w x 14" d x 24-3/4" h
- No. ■ 251BKCD350** - 30" w x 14" d x 31-1/8" h

36"W without lockable swing doors

- No. ■ 251BKC270M** - 36" w x 14" d x 24-3/4" h
- No. ■ 251BKC350M** - 36" w x 14" d x 31-1/8" h

36"W with lockable swing doors

- No. ■ 251BKCD270M** - 36" w x 14" d x 24-3/4" h
- No. ■ 251BKCD350M** - 36" w x 14" d x 31-1/8" h

(L) Bookcase Riser Back Panels

- Protected cord access holes in all four corners
- Provides privacy above for work bench applications
- Formed steel panel attaches to Riser with hardware supplied.

Specify color ■ - two digit color code

- No. ■ 251RBP6018** - 60" w x 18" h
- No. ■ 251RBP6021** - 60" w x 21" h
- No. ■ 251RBP6024** - 60" w x 24" h
- No. ■ 251RBP7218** - 72" w x 18" h
- No. ■ 251RBP7221** - 72" w x 21" h
- No. ■ 251RBP7224** - 72" w x 24" h
- No. ■ 251RBP9018** - 90" w x 18" h
- No. ■ 251RBP9021** - 90" w x 21" h
- No. ■ 251RBP9024** - 90" w x 24" h



Color Selection

Determine the color and add the two letter ■ digits as a prefix to catalog numbers.

AA Ash	BB Wedgewood Blue	DD Dove Gray	HH Red Baron	JJ Hunter Green	KK Vulcan Black	PP Putty
------------------	-----------------------------	------------------------	------------------------	---------------------------	---------------------------	--------------------

(M) Modesty Panel

- Provides privacy below for work bench applications
- Formed steel panel attaches panel leg to cabinet with hardware supplied
- Match modesty panel size to width of work surface and cabinet

Specify color ■ - two digit color code

for 60”w Work Surface with Desk/Table Slender Cabinet

No. ■ 251MDP60270SL

No. ■ 251MDP60270

for 60”w Work Surface with Bench/Mid-Range Slender Cabinet

No. ■ 251MDP60350SL

No. ■ 251MDP60350

for 72”w Work Surface with Desk/Table Slender Cabinet

No. ■ 251MDP72270SL

No. ■ 251MDP72270

for 72”w Work Surface with Bench/Mid-Range Slender Cabinet

No. ■ 251MDP72350SL

No. ■ 251MDP72350



(N-1) Under-Counter Shelves

- Provides additional storage space below work surface
- 150 lb. evenly distributed weight capacity, 12-1/2” deep
- Formed steel panel attaches to panel leg and cabinet with brackets and hardware supplied

Specify color ■ - two digit color code

for 60”w Work Surface

No. ■ 251UCS60SL - Slender Cabinet

No. ■ 251UCS60 - Standard Cabinet

for 72”w Work Surface

No. ■ 251UCS72SL - Slender Cabinet

No. ■ 251UCS72 - Standard Cabinet

(N-2) Under-Counter Shelves Side-Mounted to Cabinet

- Available in pairs for work surfaces side-mounted to the cabinet (Hi-Lo Bracket).

Specify color ■ - two digit color code

for 60”w Work Surface

No. ■ 251UCSD60 - 2 shelves

for 72”w Work Surface

No. ■ 251UCSD72 - 2 shelves



Color Selection

Determine the color and add the two letter ■ digits as a prefix to catalog numbers.

AA Ash	BB Wedgewood Blue	DD Dove Gray	HH Red Baron	JJ Hunter Green	KK Vulcan Black	PP Putty
------------------	-----------------------------	------------------------	------------------------	---------------------------	---------------------------	--------------------



Secure, High Density Weapons Storage The Ultimate Storage Solution for military, domestic defense and police professionals

Maximize your storage, workspace and security with Lyon Modular Drawer Weapons Cabinets. This high density storage solution provides a maximum level of security in an organized and efficient storage footprint.

- Meets the requirements of paragraph 4 of the Small Arms Storage Rack Certification Document; part of AR 190-11 for the physical security of arms, ammunition and explosives
- Integrated locking system at both vertical drawer ends provides for ultimate security (*padlock not included*)
- 4:1 storage space savings as compared to typical rack systems
- Rubber-coated gun partitions and foam inserts for pistols protect and secure weapons within each drawer
- All drawers feature a bottom polyester mesh liner for weapon surface protection

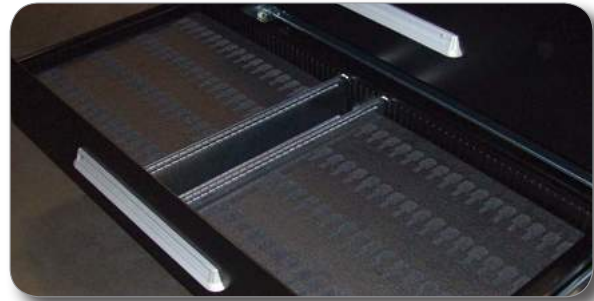

Accessories

- Choose a hardwood top work surface or add an Overhead Unit for the bulk storage of ancillary items
- Add a foam insert

Pre-engineered units are Eye-Level - 59-1/4" h x 28-1/4" d

Rifle Storage

Extra
(44-3/8" w)

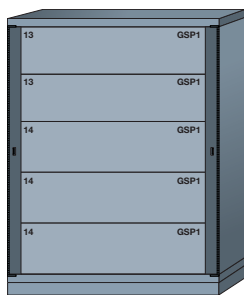

■ **N6845300WPNI**
40 Weapons
A4, MP542, M1200,
M16, M4, M4A1

Double
(59-5/8" w)

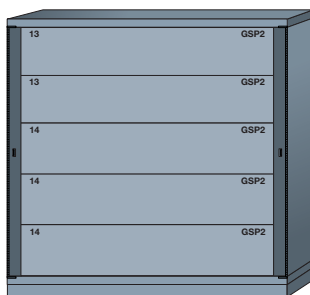

■ **N6860300WPNI**
40 Weapons
CAR15, M-1A, M24,
M16 w/M203

Pistol Storage

Slender
(22-13/16" w)

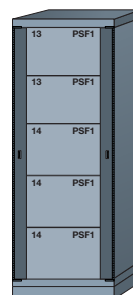

■ **N6822300WPNI**
220 Pistols

Standard
(30" w)

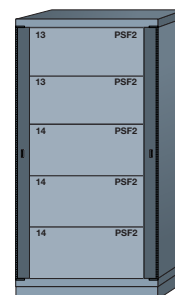

■ **N6830300WPNI**
320 Pistols

Medium
(36-3/8" w)

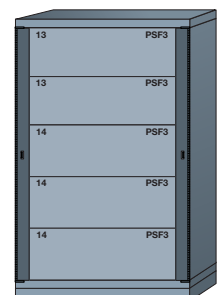

■ **N6836300WNPI**
400 Pistols

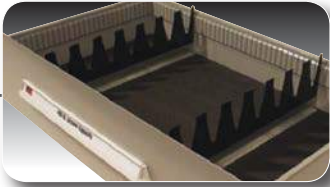

To custom design a Weapons Storage, contact Customer Service at 1-800-323-0082. Dimensions listed are the clear inside dimensions of the drawer.

Partitions (Rifle Storage)

*Weapons length must be less than 39-1/4" for storage in "Extra" (39-1/2"w) Drawer

WEAPON MODEL	DRAWER INSERT PART NUMBER <i>(includes drawer liner)</i>	MINIMUM DRAWER HEIGHT	EXTRA (39-1/2"w)	WEAPONS PER DRAWER DOUBLE (54-11/16"w)
SUBMACHINE GUN				
A4	250GSP1	130	8	---
A4	250GSP3	130	---	16
A5	250GSP1	140	8	---
A5	250GSP3	140	---	16
MP5A2	250GSP1	130	8	---
MP5A2	250GSP3	130	---	16
MP5A3	250GSP1	140	8	---
MP5A3	250GSP3	140	---	16
M3A1	250GSP5	120	11	---
M3A1	250GSP6	120	---	15
SD	250GSP1	140	8	---
SD	250GSP3	140	---	16
CARBINE				
CAR15	250GSP2	130	---	8
M4	250GSP1	130	8	---
M4	250GSP2	130	---	8
M4A1	250GSP1	130	8	---
M4A1	250GSP2	130	---	8

WEAPON MODEL	DRAWER INSERT PART NUMBER <i>(includes drawer liner)</i>	MINIMUM DRAWER HEIGHT	EXTRA (39-1/2"w)	WEAPONS PER DRAWER DOUBLE (54-11/16"w)
MACHINE GUN				
MAG-58	250GSP4	160	---	5
M240B	250GSP4	160	---	5
M240G	250GSP4	160	---	5
M249	250GSP4	160	---	5
SHOTGUN				
M1200*	250GSP1	130	8	---
M1200	250GSP2	130	---	8
RIFLE				
M16*	250GSP1	130	8	---
M16	250GSP2	130	---	8
M16 w/ M203	250GSP2	130	---	8
M-1A	250GSP2	130	---	8
SNIPER RIFLE				
M-24	250GSP2	130	---	8
BARREL				
M2	250GSP2	100	---	8

Foam Insert (Pistol Storage)

DRAWER WIDTH	DRAWER INSERT PART NUMBER <i>(includes drawer liner)</i>	MINIMUM DRAWER HEIGHT	WEAPONS PER DRAWER
Slender (17-15/16")	250PSF1	130	44
Standard (25-1/8")	250PSF2	130	64
Medium (31-1/2")	250PSF3	130	80
Extra (39-1/2")	250PSF4	130	100
Double (54-11/16")	250PSF5	130	140

Foam Insert (Rifle Storage)

WEAPON MODEL	WEAPON STYLE	DRAWER INSERT PART NUMBER <i>(includes drawer liner)</i>	MINIMUM DRAWER HEIGHT	WEAPONS PER DRAWER DOUBLE (54-11/16"w)
M2	Machine Gun	250GSF1	140	4
M60	Machine Gun	250GSF2	130	4
MK19	Machine Gun	250GSF3	130	2

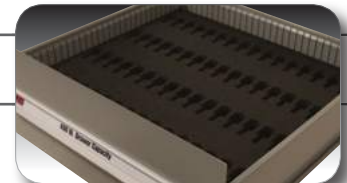

To custom design a Weapons Storage, Contact Customer Service at 1-800-323-0082

Example

For the storage of (32) A5 Submachine Guns

Qty.	Cat. No.	Description
1	PPN316030BNNNN	Double Table Housing
2	PP240ELB310	External Lockbar
1	PPN156030NN000	Double Drawer, 10-7/8"
1	250GSP3	Usable/16 Weapon Layout
1	PPN166030NN000	Double Drawer, 11-3/4"
1	250GSP3	Usable/16 Weapon Layout
1	250LHT60	Hardwood Top



All-Welded Shelf Cabinets

- All-welded 14-gauge steel construction provides a payload capacity of **1,450 lbs. per shelf**
- Heavy-duty steel doors have a padlock hasp (lock not included) and heavy-duty 5/16" brass-pin hinge plates securely welded to each door
- Shelves bolt securely into welded keyhole slots and can be repositioned on 3" centers
- Secure, 3-point locking system on doors features 3/8" latch rod and 3/16" latch plate
- 4" high legs welded to cabinet — forklift base allows for easy movement anywhere in your facility
- Additional shelves can be added for increased versatility
- Ships set up
- Available with Diamond Perf Doors



Features



Heavy-duty 14-gauge flanged shelves, adjustable on 3" centers



Rugged cast iron handles with 3/8" thick padlock hasp



Three heavy-duty 5/16" diameter steel pin hinges securely welded to each cabinet door

Color Selection

- | | |
|---------------------|--------------------------|
| In Stock | Also Available |
| DD Dove Gray | BB Wedgewood Blue |
| | KK Vulcan Black |
| | PP Putty |



1114



1120



1145

W x D x H	No. of Shelves	Shelf Capacity	Standard Doors Cat. No.	Diamond Perf Doors Cat. No.	Extra Shelf
36" x 21" x 82"	4	1,450 lbs.	1114	1114DP	11161
36" x 24" x 82"	4	1,450 lbs.	1115	1115DP	11191
48" x 24" x 82"	4	1,450 lbs.	1120	1120DP	1161
60" x 24" x 82"	4	1,450 lbs.	1145	1145DP	1146

Note: Cabinet heights include 4" h legs



1121

All-Welded Combination Cabinets

Combines garment with package and supply item storage in one convenient unit. Includes fixed, full-width top shelf.

- Three half-shelves adjustable on 3" centers
- Includes coat rod to accommodate garments on hangers
- Ships set up

W x D x H	No. of Shelves	Shelf Capacity	Cat. No.	Extra Half Shelf
36" x 24" x 82"	1 full / 4 half	1,450 lbs.	1121	1162
48" x 24" x 82"	1 full / 4 half	1,450 lbs.	1148	1165
60" x 24" x 82"	1 full / 4 half	1,450 lbs.	1149	1166

Note: Cabinet heights include 4" h legs

Color Selection

In Stock

DD Dove Gray

Also Available

BB Wedgewood Blue

KK Vulcan Black

PP Putty



1112



1110

All-Welded Counter High and Eye-Level Shelf Cabinets

All the same specifications of the All-Welded Shelf Cabinets (facing page) with a shorter height.

- Ships set up

W x D x H	No. of Shelves	Shelf Capacity	Cat. No.	Extra Shelf
36" x 21" x 64"	3	1,450 lbs.	1112	11161
36" x 24" x 64"	3	1,450 lbs.	1113	11191
36" x 21" x 46"	2	1,450 lbs.	1110	11161
48" x 24" x 64"	3	1,450 lbs.	1147	1161

Note: Cabinet heights include 4" h legs



All-Welded Clearview and 4-Door Shelf Cabinets

Quickly evaluate supply inventory without even opening the doors.

- All-welded, 14-gauge construction
- Clearview cabinets feature heavy-duty 3/16" thick Lexan® door inserts
- 14-gauge flanged shelves are adjustable on 3" centers
- Rugged cast iron handle features a 3/8" thick padlock hasp
- Three heavy-duty 5/16" brass pin hinge plates welded to each door
- Additional shelves are available for customized configurations
- 4" high welded on legs
- Forklift base allows for easy movement anywhere in your facility
- Ships set up

Color Selection

In Stock

DD Dove Gray

Also Available

BB Wedgewood Blue

KK Vulcan Black

PP Putty



Clearview Cabinet

- Includes four full-width shelves
 - Overall Size: 48"w x 24"d x 82"h
- No. 1120V**

Extra 48"w Shelf for 1120V
No. 1161



Safety Center

- Includes four full-width shelves
 - Yellow finish only
 - Overall Size: 48"w x 24"d x 82"h
- No. 1120SC**

Extra 48"w Shelf for 1120SC
No. 1161



Clearview Shelf/Bin Cabinet

- Includes three full-width shelves
- 16 large (8 1/4"w x 14 1/4"d x 7"h) plastic parts bins
- Overall Size: 36"w x 21"d x 82"h

No. 1123V

Extra 36"w Shelf for 1123V
No. 11161



Clearview Multi-Door Cabinet

- Create secure storage for 4 people in a single cabinet.
- Includes one full-width shelf per compartment
- Overall Size: 48"w x 24"d x 82"h

No. 11204DV



Multi-Door Cabinet

- Create secure storage for 4 people in a single cabinet.
- Includes one full-width shelf per compartment
- Overall Size: 48"w x 24"d x 82"h

No. 11204D

All-Welded Mobile Shelf Cabinet

Extra wide and 24" deep, also functions as a storage closet on the shop floor, offering:

- All-welded 14-gauge construction
- Load capacity of 1,450 lbs. per shelf
- Wide, double doors for easy access
- Full-width shelves are adjustable on 3" centers
- 6" polyolefin casters - 2 swivel with brakes; 2 rigid without brakes. 700 lb. capacity each, 2800 lb. total
- Overall Size: 60"w x 24"d x 67-1/2"h
- Ships set up. Casters pre-assembled, handle ships loose

No. 1170

Extra Shelf for 1170

No. 1146

Color Selection

In Stock

DD Dove Gray

Also Available

BB Wedgewood Blue

KK Vulcan Black

PP Putty



Front View



Back View



DD900

Optional black Duraflex vinyl matting **No. 910**



DD901

All-Welded Mobile Work Centers

- Ball bearing drawer slides – capacity of 100 lbs. each
- Internal shelf is adjustable on 3" centers – capacity of 1,450 lbs.
- Heavy-duty 10-gauge steel top includes back and end stops; accommodates vise installation when drilled and bolted (vise not included)
- Smooth-rolling, 8" diameter, 2" wide roller bearing Phenolic casters (2 fixed, 2 swivel-braking) provide a total load capacity of 3600 lbs.
- Steel doors feature a padlock hasp, a spring-actuated pull handle that holds the doors in the closed position, and two (2) heavy-duty 5/16" brass pin hinge plates welded to each door
- Cabinet, Dove Gray; Drawers, Red Baron
- Ships set up. Casters pre-assembled, handle ships loose

No. DD900 - with Drawers

No. DD901 - without Drawers

Dimensions For Components

Description	Width	Depth	Height
Overall	48"	26"	36"
5 Drawers	22 ⁷ / ₈ "	17 ³ / ₄ "	2 ⁷ / ₈ "
1 Drawer	22 ⁷ / ₈ "	17 ³ / ₄ "	6"
Inside Top Shelf	17 ³ / ₄ "	18 ¹ / ₂ "	11"
Inside Lower Shelf	17 ³ / ₄ "	18 ¹ / ₂ "	10"
Rear Top Shelf	47 ³ / ₄ "	5 ¹ / ₄ "	11 ³ / ₄ "
Rear Lower Shelf	47 ³ / ₄ "	5 ¹ / ₄ "	12 ¹ / ₈ "



All-Welded Cabinets with Removable Bins

- All-welded 14-gauge steel construction delivers secure storage behind heavy-gauge steel doors
- Evenly distributed load capacity: 1,450 lbs. per shelf
- 3-point locking system featuring 3/8" latch rods and 3/16" latch plates
- Additional shelves can be added for increased versatility
- 4" high welded on legs
- Forklift base allows for easy movement anywhere in your facility
- Ships set up. Plastic bins ship loose in boxes within cabinet

ACCESSORIES AND RELATED PRODUCTS



78222

Extra Plastic Bins for Bin Cabinets

No. 78228 - Large, 8-1/4"w x 14-3/4"d x 7"h (60 lb. capacity)

No. 78222 - Small, 4-1/8"w x 5-3/8"d x 3"h (10 lb. capacity)

Extra Dividers

No. 78229 - Divider for 78228

No. 78223 - Divider for 78222

**Plastic Bins and Dividers are imported.*

Extra Shelves

No. 11161 - Extra Shelf, 36"w x 18-9/16"d

No. 1163 - Extra Half Shelf, 14"w x 18-9/16"d

Color Selection

In Stock

DD Dove Gray

Also Available

BB Wedgewood Blue

KK Vulcan Black

PP Putty



Features

Removable plastic parts bins increase storage density, speed selection and retrieval. Corrosion resistant, and impervious to most solvents, Safety Yellow plastic bins easily clip on and off racks welded to cabinets and doors.



Combination/Bin Cabinet

- Includes one full-width shelf
- 3 half-shelves adjustable on 3" centers with 50 small (4-1/8"w x 5-3/8"d x 3"h) plastic bins on door
- 14 large (8-1/4"w x 14-3/4"d x 7"h) plastic bins inside cabinet
- Overall Size: 36"w x 21"d x 82"h

No. 1122



Shelf/Bin Cabinet

- Includes 3 full-width shelves adjustable on 3" centers
- 16 large (8 3/4"w x 14 3/4"d x 7"h) plastic bins inside cabinet
- Overall Size: 36"w x 21"d x 82"h

No. 1123



Bin Storage Cabinet

- Includes 100 small (4 1/8"w x 5 3/8"d x 3"h) plastic bins on doors
- 36 large (8 3/4"w x 14 3/4"d x 7"h) plastic bins inside cabinet
- Overall Size: 36"w x 21"d x 82"h

No. 1124

**All-Welded Cabinet
with Removable Bins**



Bin Storage Cabinet

- Includes 136 small (4 $\frac{1}{8}$ "w x 5 $\frac{5}{8}$ "d x 3"h) plastic bins on doors
- 45 large (8 $\frac{1}{4}$ "w x 14 $\frac{3}{4}$ "d x 7"h) plastic bins inside cabinet
- Overall Size: 48"w x 21"d x 82"h

No. 1136



Bin Storage Cabinet

- Includes 170 small (4 $\frac{1}{8}$ "w x 5 $\frac{5}{8}$ "d x 3"h) plastic bins on doors
- 54 large (8 $\frac{1}{4}$ "w x 14 $\frac{3}{4}$ "d x 7"h) plastic bins inside cabinet
- Overall Size: 60"w x 21"d x 82"h

No. 1141



Shelf/Bin Cabinet

- Includes 4 full-width shelves adjustable on 3" centers
- 81 small (4 $\frac{1}{8}$ "w x 5 $\frac{5}{8}$ "d x 3"h) plastic bins on doors
- Overall Size: 36"w x 21"d x 82"h

No. 1155



Shelf/Bin Cabinet

- Includes 3 full-width shelves, adjustable on 3" centers
- 86 small (4 $\frac{1}{8}$ "w x 5 $\frac{5}{8}$ "d x 3"h) plastic bins on doors
- 16 large (8 $\frac{1}{4}$ "w x 14 $\frac{3}{4}$ "d x 7"h) plastic bins inside cabinet
- Overall Size: 36"w x 21"d x 82"h

No. 1156



All-Welded Deep-Door Cabinets With Removable Tilt-Bins

- All-welded 14-gauge steel construction delivers secure storage behind heavy-gauge steel doors
- Evenly distributed load capacity: 1,450 lbs. per shelf
- 3-point locking system featuring $\frac{3}{8}$ " latch rods and $\frac{3}{16}$ " latch plates
- Additional shelves can be added for increased versatility
- 4" high welded on legs
- Forklift base allows for easy movement anywhere in your facility

Color Selection

In Stock

DD Dove Gray

Also Available

BB Wedgewood Blue

KK Vulcan Black

PP Putty

Features



Hard composition casters underneath swing out doors maintain positive alignment, provide smooth door opening and closing under heavy loads. Casters and legs provide clearance for forklift access.

Choose from our exclusive, Easy Access Tilt-Bins or Standard Bins.



Tilt-Bins



Standard Bins



Four-Shelf, 24 Bin Cabinet

- 4 full-width shelves adjustable on 3" centers
- 12 removable tilt-bins in each door
- Overall Size: 39"w x 27"d x 76"h

No. 1125



Two-Shelf, 40 Bin Cabinet

- 2 full-width shelves adjustable on 3" centers
- 16 large removable plastic bins (8 $\frac{1}{4}$ "w x 14 $\frac{3}{4}$ "d x 7"h) in cabinet
- 12 removable tilt-bins in each door
- Overall Size: 39"w x 27"d x 76"h

No. 1126

**All-Welded Deep-Door Cabinets
With Removable Tilt-Bins**

NOTE: Interior depth of cabinet is 21". Doors are 5 5/8" deep. Cabinets ship with shelves bolted in and doors casters pre-assembled, ready-to-use as shown. Tilt-bins pre-assembled. Large plastic bins shipped loose in boxes within cabinet.

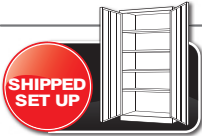

ACCESSORIES AND RELATED PRODUCTS

Extra Plastic Parts Bins and Dividers

Unique Tilt-Bins swing forward to allow 100% access to contents, then tilt back for storage. Easily removed, 15"w x 5"d x 5 1/2"h. Tilt-Bins add more storage density for small parts and equipment.



3427BWYB
(shown with optional dividers)

No. 78228 – Large Parts Bins, 8 1/4"w x 14 3/4"d x 7"h (60 lb. capacity)

No. 78229 – Large Parts Bin Dividers

No. 3427BWYB – Tilt-Bins, 15"w x 5"d x 5 1/2"h (40 lb. capacity)

No. 3445BWYB-18 – Tilt-Bin Dividers

**Plastic Parts Bins and Dividers are imported.*

Extra Shelves

No. 1160 – Extra Shelf, 38"w x 18 9/16"d

No. 1164 – Extra Half Shelf, 16"w x 18 9/16"d - only fits No. 1128



Four-Shelf, 12 Bin Cabinet

- 4 full-width shelves adjustable on 3" centers
- 6 removable tilt-bins and 3 adjustable on 5 1/2" centers (75 lb. capacity) shelves in each door [Drawer case unit not included]
- Overall Size, 39"w x 27"d x 76"h

No. 1127



Four-Shelf, 36 Bin Cabinet

- 1 full-width shelf, 3 half-shelves adjustable on 3" centers
- 12 large removable plastic bins
- 12 removable tilt-bins in each door
- Overall Size, 39"w x 27"d x 76"h

No. 1128



All-Welded Maintenance Centers with Modular Drawers

Payload Capacity: 400 lbs. per drawer!

Safely store tools, equipment, maintenance and repair parts, even personal effects. There's even a slide-out work surface for light maintenance and repair work.

- All-welded 14-gauge steel construction
- 400 lb. drawer capacity
- Forklift accessible base
- Ball-bearing drawer suspension

Color Selection

In Stock

DD Dove Gray

Also Available

BB Wedgewood Blue

KK Vulcan Black

PP Putty



IMPORTANT: Other drawer sizes are available. Contact Lyon at 1-800-323-0082 for details.



39" Wide Cabinet with Modular Drawers

- One modular drawer 31½" w x 2¼" h* with latch-in/latch-out & flip-up drawer cover kit that provides a work surface for light-duty maintenance work
- 1 modular drawer, 31½" w x 3" h*
- 2 modular drawers, 31½" w x 4⅝" h*
- Hinged lock bar on modular drawers
- 2 adjustable shelves, 39" w
- 8 tilt bins (15" w x 5" d x 5½" h) per door
- 2 shelves per door
- Overall Size: 39" w x 36½" d x 76" h

No. 1104F

*Interior drawer dimensions, all drawers are 25⅞" d

Features



Heavy-duty 14-gauge flanged shelves, adjustable on 3" centers.



Rugged cast iron handles with ⅜" thick padlock hasp.



Hard composition casters underneath swing out doors maintain positive alignment, provide smooth door opening and closing under heavy loads. Casters and legs provide clearance for forklift access.

All-Welded Maintenance Centers with Modular Drawers

60" Wide Cabinet with Modular Drawers

- 1 modular drawer, 39½" w x 2¼" h*
- 1 modular drawer, 39½" w x 3" h*
- 2 modular drawers, 39½" w x 9¾" h*
- Hinged lock bar on modular drawers
- 400 lb. capacity roll out shelf
- 18 tilt bins (15" w x 5" d x 5½" h)
- 5 adjustable shelves in right-hand door
- 1 shelf/coat rod (14" w x 21½" d)
- Overall Size: 60" w x 36½" d x 60" h

No. 1101F

**Interior drawer dimensions, all drawers are 25⅞" d*



60" Wide Cabinet with Modular Drawers

- 1 modular drawer, 39½" w x 2¼" h*
- 1 modular drawer, 39½" w x 3" h*
- 2 modular drawers, 39½" w x 9¾" h*
- 400 lb. capacity roll out shelf
- Hinged lock bar on modular drawers
- 18 tilt-bins (15" w x 5" d x 5½" h)
- 52 small plastic bins (4⅞" w x 5⅞" d x 3" h)
- 1 shelf/coat rod (14" w x 21½" d)
- Overall Size: 60" w x 36½" d x 60" h

No. 1102F

**Interior drawer dimensions, all drawers are 25⅞" d*



60" Wide Cabinet with Modular Drawers

- One modular drawer 31½" w x 2¼" h* with latch-in/latch-out & flip-up drawer cover kit that provides a work surface for light-duty maintenance work
- 1 modular drawer, 31½" w x 3" h*
- 2 modular drawers, 31½" w x 4⅞" h*
- 2 modular drawers, 31½" w x 9¾" h*
- Hinged lock bar on modular drawers
- 3 adjustable shelves, 21¼" w x 21½" d
- 18 tilt-bins (15" w x 5" d x 5½" h) in left-hand door
- 5 adjustable shelves in right-hand door
- Overall Size: 60" w x 36½" d x 60" h

No. 1103F

**Interior drawer dimensions, all drawers are 25⅞" d*



1000 Series Storage Cabinets

- Contemporary styling with rounded front corners
- Three-point door locking system
- Polished chrome plated handles. Separate grooved key lock with 2 keys
- Pan type reinforcements maintain door alignment
- "Quiet Door" feature reduces noise when opening and closing doors
- Durable heavy-gauge steel construction
- Shelf adjustments on 2" centers



Features

Back corners are slotted and front corners are supported with clips for easy adjustment



1042



1035

Counter High Cabinets

- Provides 24 cu. ft. of storage space
- Waist high



Note: Reinforced shelves boost the load capacity of standard 36" w shelves to 230 lbs. Contact Customer Service at 1-800-323-0082 for special ordering information.

W x D x H	No. of Shelves	Shelf Capacity	Set Up Cat. No.	K.D. Cat. No.	Extra Shelf	Reinforced Shelf
36" x 18" x 42"	2	180 lbs.	1042	1043	10551	10711
36" x 21" x 42"	2	180 lbs.	1040	1041	10501	10701
36" x 24" x 42"	2	180 lbs.	1045	1046	10601	10721
48" x 24" x 42"	2	325 lbs.	1035SU	1035	10581	N/A

Color Selection

In Stock

- DD Dove Gray
- PP Putty

Also Available

- BB Wedgewood Blue
- KK Vulcan Black

Standard Cabinets

- A virtual storeroom of space – holds up to 2,000 total lbs.
- Double doors permit full access to all areas of cabinet



1080



1031

W x D x H	No. of Shelves	Shelf Capacity	Set Up Cat. No.	K.D. Cat. No.	Extra Shelf	Reinforced Shelf
36" x 18" x 78"	4	180 lbs.	1080	1081	10551	10711
36" x 21" x 78"	4	180 lbs.	1000	1001	10501	10701
36" x 24" x 78"	4	180 lbs.	1090	1091	10601	10721
48" x 24" x 78"	4	325 lbs.	1031SU	1031	10581	N/A



"Set Up" means product ships fully assembled

"K.D." means knocked down, ships flat and assembly is needed

Combination Wardrobe Cabinets

- 4 side-shelves with 2" adjustability and 5 compartments maximize storage space
- Full-width shelf at top for hats and other articles
- Coat rod below shelf
- Smooth, snag-free finished interior



1088



1033

W x D x H	No. of Shelves	Set Up Cat. No.	K.D. Cat. No..	Extra Half Shelf
36" x 18" x 78"	1 full / 4 half	1088	1089	10571
36" x 21" x 78"	1 full / 4 half	1010	1011	10521
36" x 24" x 78"	1 full / 4 half	1098	1099	10621
48" x 24" x 78"	1 full / 4 half	1033SU	1033	10631

Color Selection

In Stock

DD Dove Gray

PP Putty

Also Available

BB Wedgewood Blue

KK Vulcan Black

Wardrobe Cabinets

- Full-width shelf at top for hats and other articles
- Coat rod below shelf
- Smooth, snag-free finished interior



1085



1032

W x D x H	No. of Shelves	Set Up Cat. No.	K.D. Cat. No.	Extra Shelf	Extra Shelf with Coat rod
36" x 18" x 78"	1	1085	1086	10551	1056
36" x 21" x 78"	1	1005	1006	10501	1051
36" x 24" x 78"	1	1095	1096	10601	1061
48" x 24" x 78"	1	1032SU	1032	10581	1059



1000 SERIES VISIBLE STORAGE CABINETS

Bring the Inside Out

- Plexiglas® windows on both doors provides visual inventory without opening them
- Three-point door locking system provides outstanding security with key lock
- Shelf reinforcements increase shelf capacity to 230 lbs.
- Four shelves adjustable on 2" centers (additional shelves available - contact customer service).

Color Selection

DD Dove Gray

PP Putty

Set Up with Four Shelves

No. 1080V - 36" x 18" x 78"

No. 1090V - 36" x 24" x 78"

Knocked Down with Four Shelves

No. 1081V - 36" x 18" x 78"

No. 1091V - 36" x 24" x 78"

Extra Shelf

No. 10551 - 18"

No. 10601 - 24"

Reinforced Shelf

No. 10711 - 18"

No. 10721 - 24"

Visible Storage Cabinets

- All-welded construction
- Five pre-engineered configurations featuring shelves, bins and shelf-bin combinations
- Provide secure, visible storage for quick inspection without needless opening
- Full length doors feature a three-point latch design and cam-bar system
- Chrome plated handle will accept a padlock (not included), can accommodate flat key lock (optional)
- Shelves bolt into place and are adjustable on 2" centers with payload capacity of 300 lbs. each
- Plastic Bins, impervious to most solvents and corrosives, clip on and off galvanized Pick Racks bolted to cabinet back
- Shelves are included, but not installed
- All bins shown are 5 7/8" w x 11 1/8" d x 5" h with capacity of 285 cu. in.
- 36" w x 72" h



ACCESSORIES AND RELATED PRODUCTS

- No. 11371** - 36" w x 18" d Shelf
- No. 11381** - 36" w x 21" d Shelf
- No. 1142** - 18" d x 4" h Base
- No. 1143** - 21" d x 4" h Base
- No. 11403** - 36" w Galvanized Pick Rack
- No. 78203** - 4 1/8" w x 5 7/8" d x 3" h Plastic Bin
- No. 78206** - 4 1/8" w x 7 7/8" d x 3" h Plastic Bin
- No. 78209** - 5 1/2" w x 10 7/8" d x 5" h Plastic Bin

Description	No. of Shelves	No. of Bins	Cat. No.
18" Deep Cabinet	2	15	1152
18" Deep Cabinet with 4" base	2	15	1152B
18" Deep Cabinet	4	0	1150
18" Deep Cabinet with 4" base	4	0	1150B
18" Deep Cabinet	0	45	1154
18" Deep Cabinet with 4" base	0	45	1154B
21" Deep Cabinet	2	15	1153
21" Deep Cabinet with 4" base	2	15	1153B
21" Deep Cabinet	4	0	1151
21" Deep Cabinet with 4" base	4	0	1151B

Color Selection

- In Stock**
- Also Available**
- DD** Dove Gray
- BB** Wedgewood Blue
- PP** Putty



High Visibility Storage Cabinet

- Three walls of mesh for extra visibility
- Reinforcing K-brace welded to the door frame delivers added strength and proper door alignment
- 13-gauge diamond shaped steel mesh stands up to heavy use
- Adjustable shelves bolt into holes spaced from 8 3/4" at bottom to 8 3/4" from top
- Full length door has three-point latching system with cam-locking system and chrome plated handle
- Ships set up
- Overall Size: 24" w x 21" d x 78" h

No. 1130





Shelving Selection Guide



	Industrial (pg 42-46)	Galvanized (pg 47)	Painted Wire (pg 48)	Commercial (pg 57)	Rivet (pg 64-66)
APPLICATION	All-purpose standard and heavy-duty storage.	High humidity, unheated storage; storage of solvents, oily or greasy parts.	Light industrial; for cleanliness and sprinkler access.	Commercial office, light industrial. Individual, stand alone sections.	Light industrial, record storage, commercial.
SHELF CONSTRUCTION	18, 20, 22-ga. box, 18-ga. flanged, lapped and welded.	18-ga. flanged, corners lapped and welded	Channel frame w/ 3/8", 1/2" wire ribbing.	Dbl.-flanged at front and rear; comers lapped and welded.	Particle board with 14-ga. steel beams.
UPRIGHT CONSTRUCTION	T-Post, O.A., 16-ga. cold rolled, formed steel. Double thick.	T-Post 16-ga. cold-rolled formed steel. Double thick.	T-Post 16-ga. cold-rolled formed steel. Double thick.	Offset Angle or offset	14-ga. steel, angle or T-Post
ADJUSTABILITY	1 1/2" centers	1 1/2" centers	1 1/2" centers	Offset 1 1/2" centers	1 1/2" centers
AVAILABLE WIDTHS	36", 42", 48"	36"	36", 48"	Offset 36, 42, 48	12"-96" in 12" increments. 69" R.S.
AVAILABLE DEPTHS	12", 18", 24"	12", 18", 24"	18", 24"	18" 24"	12", 24" - 48", in 6" increments.
AVAILABLE HEIGHTS	84", 96", 120"	84", 96", 120"	84", 96", 120"	Offset 84", 96", 120"	60", 72", 84", 96", 120"
TYPICAL SHELF CAPACITIES	600-1300 lbs.	700-800 lbs.	400-600 lbs.	600 lbs.	600-1200 lbs.
STOCK COLORS	Dove Gray, Putty, Wedgewood Blue	Shelves: Galvanized, Uprights: Gray, Putty, Blue	Dove Gray	Dove Gray, Putty	Dove Gray, Putty

Growth Illustration Chart - 8000 Series Shelving

Growth Illustration for a 36" w x 24" d Shelving System
 Shelf dimensions: 35-13/16" w x 23-15/16" d
 Centerline of T-Posts: 36"
 Overall growth in width = 1-1/2"
 Overall growth in depth = 9/16"



Lyon's Steel Shelving, and Storage Racks conform to MHI, ISMA, RMI and SMA standards.



Materials

Roll-formed "T" uprights-hot-rolled steel, gauges specified. **Shelf clips**-hot-rolled steel, gauges specified. **Other sheet steel**-cold-rolled and hot-rolled, gauges specified.

Uprights

"T" Uprights - all posts punched on 1 1/2" centers with pairs of parallel slots 1 1/8" long, and 1 slot keyhole-shaped for bolting cross braces and accessories to uprights.

Open Uprights - consist of 2 16-gauge, hot-rolled, formed steel "T"s 1 1/2" x 2 1/8" x 1/8" with 1 pair of 1" x 12-gauge band cross braces on uprights less than 120" high. Uprights 120" and higher - 2 or more pairs of 1" x 12-gauge band cross braces as required.

Closed Uprights - 2 16-gauge, hot-rolled, formed steel "T"s 1 1/2" x 2 1/8" x 1/8" with 24-gauge side sheet spot-welded on 6" centers to the 1/2" extension of the "T".

Offset Angle Uprights - all uprights shall be punched on 1 1/2" centers with pairs of parallel slots 1 3/16" long with 1 slot to have an 1 1/32" diameter hole in center for the attachment of cross braces, bolting shelving and other accessories. The end of each slot is embossed to ensure perfect clip fit-up.

Open uprights - two 13-gauge, hot-rolled, formed steel "offset angles" 1" x 2 3/8" with 1 pair of 1" x 12-gauge band cross braces on uprights less than 96" high. Uprights 96" and higher shall have 2 or more pairs of 1" x 12-gauge band cross braces as required.

Closed uprights - two 13-gauge, hot-rolled, formed steel "offset angles" 1" x 2 3/8" with 24-gauge side sheet. Side sheets are punched with holes for bolting to uprights.

"Box Post" Uprights - all posts shall be punched on 1 1/2" centers to accept either clip attachment or bolt attachment. Each upright shall consist of (2) 14-gauge, hot-rolled, formed steel "box posts" 1 3/4" x 1 13/16" with (2) 4 1/16" x 12-gauge ladder braces on uprights of 96" or less. 120" and 144" uprights require three ladder braces.

Shelf Clips - 12 gauge, hot-rolled, 1-piece construction. Four shelf clips used with each shelf.

NOTE: "Box post" uprights require the use of the 65160 integration clip.

Shelves

Medium Duty (M) Industrial Shelves - 22-gauge with front and rear "Box W" formation. The front and rear "Box W" formation is not less than 1 1/64" x 2 7/32" x 1 1/8" with a 9/16" return flange spot-welded to bottom surface of the shelf. The 2 7/32" portion of the "Box W" formation shall have a 10-degree bend in the center for additional strength and rigidity. The front and rear flanges of the shelf shall be punched to accept bin fronts, label holders and other accessories. Ends are to be flanged not less than 1 1/64" with a 90-degree return flange of not less than 5/8". All corners lapped and welded. All shelves punched on 3" centers for divider attachment. The front and rear flanges of the shelf are to be embossed with "22 GA." Shelves also punched at 4 corners for bolting to uprights.

Traditional Industrial Shelves - 18-gauge with front and rear flanged down not less than 1 1/64" with return flange of not less than 3/8" at approximately 10 degrees, and punched to accommodate label holder and accessories. Ends are to be flanged not less than 1 1/64" with a 90-degree return flange of not less than 5/8". All corners lapped and welded. All shelves punched on 3" centers for divider attachment. The front and rear flanges are to be embossed with "18 GA." Must request punching for bolting to uprights for 12", 18", 24" and 36".

Heavy Duty (H) Industrial Shelves - 20-gauge with front and rear "Box W" formation. The front and rear "Box W" formation is not less than 1 1/64" x 2 7/32" x 1 1/8" with a 9/16" return flange, spot-welded to the bottom portion of the shelf. The 2 7/32" portion of the "Box W" formation shall have a 10-degree bend in the center for additional strength and rigidity. The front and rear flanges of the shelf shall be punched to accept bin fronts, label holders and other accessories. Ends are to be flanged not less than 1 1/64" with a 90-degree return flange of not less than 5/8". All corners lapped and welded. All shelves punched on 3" centers for divider attachment. The front and rear flanges of the shelf are to be embossed with "20 GA." Shelves also punched at 4 corners for bolting to uprights.

Extra Heavy Duty (X) Industrial Shelves - 18-gauge with front and rear "Box W" formation. The front and rear "Box W" formation is not less than 1 1/64" x 2 7/32" x 1 1/8" with a 9/16" return flange spot-welded to the bottom portion of the shelf. The 2 7/32" portion of the "Box W" formation shall have a 10-degree bend in the center for additional strength and rigidity. The front and rear flanges of the shelf shall be punched to accept bin fronts, label holders and other accessories. Ends are to be flanged not less than 1 1/64" with a 90-degree return flange of not less than 5/8". All corners lapped and welded. All shelves punched on 3" centers for divider attachment. Shelves also punched at four corners for bolting to uprights. The front and rear flanges of the shelf are to be embossed with "18 GA." Shelves also punched at 4 corners for bolting to uprights.

Lateral Cross Braces - 1" x 12-gauge band formed and punched at each end to bolt to upright post. One pair of lateral cross braces - used with every three shelving sections with shelf spacing less than 30". Shelving sections with 30" or greater shelf spacings - two pairs of lateral cross braces with every three shelving sections.

Backs - two half panels of heavy gauge steel providing a total of three vertical rows of holes on 1 1/2" centers for attachment to shelves with back to shelf clips optional and with three screws at the top and bottom shelves, two at midpoint.

Shelf Boxes - heavy-gauge steel body with divider slots on 1" centers of box sides. Heavy-gauge box fronts have integral handle and card holder and backs have integral "E" stop.

Label Holders - 24-gauge steel, friction type with 7/8" inside dimension, and attached to shelves with three spring fasteners.

Crosswise Dividers - Front and rear edges - 3/8" O.D. curls. Top and bottom - flanges not less than 3/4" punched for attaching to shelves. All crosswise dividers up to 18" high and 21" deep are heavy-gauge steel. Crosswise dividers over 18" high and 21" deep are heavy-gauge steel.

Lengthwise Dividers - Range from 22-gauge to 18-gauge steel depending upon shelf spacings.

Bin Fronts - Top and bottom edges - 7/16" O.D. curl. Each end - 1/4" offset to engage upright "T"s. Bin fronts - punched to screw to the front flange of shelves. Label holder tags on 2" centers - provided on 3" bin fronts. 1" bin fronts - heavy gauge steel 3" bin fronts wider than 42" shall be heavy gauge.

Bases - channel shaped with ends constructed to engage upright "T"s and lock in place with a spring fastener. 3" high base - heavy gauge steel and 6" high bases shall be heavy gauge.

Swinging Doors - heavy-gauge steel with one full-height heavy-gauge pan reinforcement per door. Each pair of double swinging doors has three-point latching with one built-in lock. One pair of double swinging doors covers one full section of 36" wide shelving.

Counter Tops - 14-gauge steel with cornice formation at front and rear. 16-gauge end finishing strips attached with bolts.

Ledges and Ledge Tops - 14-gauge steel with cornice formation at front. Optional 16-gauge end finishing strips attached with bolts. Ledge shelves - 18-gauge with optional Class 2 front flange reinforcements. Ledge shelves - bolted to front flanges of existing shelves and attached to two front upright "T"s with 12-gauge shelf clips. NOTE: For T-Post upright only.

Seismic Information - Lyon is equipped to handle all seismic requirements. Contact your local Lyon factory representative for specific seismic information relating to your area.

Shelf Clips

Quickly lock into place, on either side of uprights. Disengages easily to re-position shelves, no tools needed.

T-Post Uprights

Patented design, formed of tough, durable hot-rolled steel affords easy shelf adjustments on 1½" centers using shelf clips.

Shelf Options



22-Gauge Medium-Duty, Box "W" shelves provide up to 600 lb. capacity* for storage of aerosols, tools, drills, safety supplies, etc.



20-Gauge Heavy-Duty, Box "W" shelves provide up to 900 lb. capacity* to hold grinders, wheels, gears, sprockets, and other similar articles.



18-Gauge Extra Heavy-Duty, Box "W" shelves provide up to 1,300 lb. capacity* for storing motors, pumps, and other heavy equipment.



18-Gauge Traditional Flanged shelves provide up to 700 lb. capacity* for electrical fittings, clamps, etc.



Shelf Clips

All shelving units come with 4 shelving clips per shelf.



T-Post Uprights

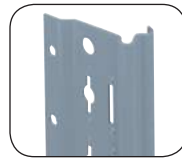

Angle Uprights

see page 57



*Capacities are based on evenly distributed loads. All shelves maintain a 1.65 safety factor and posts a 1.92 factor. See page 43 for detailed product specifications. Maximum load capacity per section is 8,000 lbs. based on 18" maximum shelf spacing and no seismic considerations.



Shelf Load Capacities for 8000 Series Shelving

Size W x D	22-Ga. Medium Box "W"		20-Ga. Heavy Duty Box "W"		18-Ga. Extra Heavy Duty Box "W"		18-Ga. Traditional Flanged	
	Cat. No.	Capacity	Cat. No.	Capacity	Cat. No.	Capacity	Cat. No.	Capacity
30" x 30"	N/A	N/A	8593H	800 lbs.	N/A	N/A	N/A	N/A
36" x 12"	8560M	600 lbs.	8560H	800 lbs.	8560X	1,150 lbs.	8560	550 lbs.
36" x 15"	8584M	600 lbs.	8584H	825 lbs.	8584X	1,200 lbs.	8584	600 lbs.
36" x 18"	8561M	600 lbs.	8561H	900 lbs.	8561X	1,300 lbs.	8561	650 lbs.
36" x 24"	8562M	600 lbs.	8562H	800 lbs.	8562X	1,150 lbs.	8562	700 lbs.
36" x 30"	N/A	**	8585H	740 lbs.	8585X	950 lbs.	8585	500 lbs.
36" x 36"	N/A	**	8586H	640 lbs.	8586X	850 lbs.	8586	450 lbs.
42" x 12"	N/A	**	8565H	650 lbs.	8565X	830 lbs.	8565	500 lbs.
42" x 15"	N/A	**	8587H	650 lbs.	8587X	880 lbs.	8587	475 lbs.
42" x 18"	N/A	**	8566H	720 lbs.	8566X	900 lbs.	8566	450 lbs.
42" x 24"	N/A	**	8567H	700 lbs.	8567X	880 lbs.	8567	500 lbs.
42" x 30"	N/A	**	8588H	650 lbs.	8588X	850 lbs.	8588	400 lbs.
42" x 36"	N/A	**	8589H	625 lbs.	8589X	820 lbs.	8589	325 lbs.
48" x 12"	N/A	**	8300H	600 lbs.	8300X	750 lbs.	8300	350 lbs.
48" x 15"	N/A	**	8590H	600 lbs.	8590X	700 lbs.	8590	325 lbs.
48" x 18"	N/A	**	8301H	600 lbs.	8301X	700 lbs.	8301	300 lbs.
48" x 24"	N/A	**	8302H	560 lbs.	8302X	750 lbs.	8302	300 lbs.
48" x 30"	N/A	**	8591H	540 lbs.	8591X	730 lbs.	8591	300 lbs.
48" x 36"	N/A	**	8592H	480 lbs.	8592X	640 lbs.	8592	300 lbs.

Shelves available in multi- or single pack quantities. Contact Lyon Customer Service at 800-323-0082.

**Please consult your factory representative, Lyon does not generally recommend 22-gauge for industrial shelving requirements larger than 36" x 24"

**Pre-Engineered
36" Wide 8000
Series Storage
Shelving Sections**



**Five Shelf
Open Starter**



**Five Shelf
Open Add-On**



**Five Shelf
Closed Starter**



**Five Shelf
Closed Add-On**

All pre-engineered sections are 36" wide, 84" high, with shelves adjustable on 1½" centers. For double row, back-to-back installations, use economical open back shelving on one side, common backs of closed shelving sections on the other side. Some assembly required. *Parts and components, see pages 54-55.*

Open Shelving Sections - Ideal for storing packaged stock and other material where high visibility is a concern.

Closed Shelving Sections - Can be used to divide work and storage space into separate areas.

Color Selection

- In Stock**
- DD** Dove Gray
- Also Available**
- PP** Putty
- BB** Wedgewood Blue

No. of Shelves	36" w x 12" d x 84" h		36" w x 18" d x 84" h		36" w x 24" d x 84" h		36" w x 12" d x 84" h		36" w x 18" d x 84" h		36" w x 24" d x 84" h	
	STARTERS	ADD-ONS	STARTERS	ADD-ONS	STARTERS	ADD-ONS	STARTERS	ADD-ONS	STARTERS	ADD-ONS	STARTERS	ADD-ONS
22-GAUGE MEDIUM DUTY, BOX "W" OPEN SHELVING							22-GAUGE MEDIUM DUTY, BOX "W" CLOSED SHELVING					
5	8005SM	8005M	8006SM	8006M	8007SM	8007M	8037SM	8037M	8038SM	8038M	8039SM	8039M
6	8040SM	8040M	8041SM	8041M	8042SM	8042M	8260SM	8260M	8261SM	8261M	8262SM	8262M
6**	N/A	N/A	N/A	N/A	N/A	N/A	8270SM	8270M	8271SM	8271M	8272SM	8272M
7	8030SM	8030M	8031SM	8031M	8032SM	8032M	8090SM	8090M	8091SM	8091M	8092SM	8092M
8	8020SM	8020M	8021SM	8021M	8022SM	8022M	8080SM	8080M	8081SM	8081M	8082SM	8082M
20-GAUGE HEAVY DUTY, BOX "W" OPEN SHELVING							20-GAUGE HEAVY DUTY, BOX "W" CLOSED SHELVING					
5	8005SH	8005H	8006SH	8006H	8007SH	8007H	8037SH	8037H	8038SH	8038H	8039SH	8039H
6	8040SH	8040H	8041SH	8041H	8042SH	8042H	8260SH	8260H	8261SH	8261H	8262SH	8262H
6**	N/A	N/A	N/A	N/A	N/A	N/A	8270SH	8270H	8271SH	8271H	8272SH	8272H
7	8030SH	8030H	8031SH	8031H	8032SH	8032H	8090SH	8090H	8091SH	8091H	8092SH	8092H
8	8020SH	8020H	8021SH	8021H	8022SH	8022H	8080SH	8080H	8081SH	8081H	8082SH	8082H
18-GAUGE EXTRA HEAVY DUTY, BOX "W" OPEN SHELVING							18-GAUGE EXTRA HEAVY DUTY, BOX "W" CLOSED SHELVING					
5	8005SX	8005X	8006SX	8006X	8007SX	8007X	8037SX	8037X	8038SX	8038X	8039SX	8039X
6	8040SX	8040X	8041SX	8041X	8042SX	8042X	8260SX	8260X	8261SX	8261X	8262SX	8262X
6**	N/A	N/A	N/A	N/A	N/A	N/A	8270SX	8270X	8271SX	8271X	8272SX	8272X
7	8030SX	8030X	8031SX	8031X	8032SX	8032X	8090SX	8090X	8091SX	8091X	8092SX	8092X
8	8020SX	8020X	8021SX	8021X	8022SX	8022X	8080SX	8080X	8081SX	8081X	8082SX	8082X
18-GAUGE TRADITIONAL FLANGED OPEN SHELVING							18-GAUGE TRADITIONAL FLANGED CLOSED SHELVING					
5	8005S	8005	8006S	8006	8007S	8007	8037S	8037	8038S	8038	8039S	8039
6	8040S	8040	8041S	8041	8042S	8042	8260S	8260	8261S	8261	8262S	8262
6**	N/A	N/A	N/A	N/A	N/A	N/A	8270S	8270	8271S	8271	8272S	8272
7	8030S	8030	8031S	8031	8032S	8032	8090S	8090	8091S	8091	8092S	8092
8	8020S	8020	8021S	8021	8022S	8022	8080S	8080	8081S	8081	8082S	8082

**NOTE: Back open with lateral cross brace.



Pre-Engineered 42" and 48" Wide 8000 Series Storage Shelving Sections

Wider for Greater Storage Flexibility

- Greater lateral clearance yields more shelf space for long, unwieldy items and offers more flexibility for storing packaged stock
- Both 42" and 48" wide sections integrate with comparable 36" wide 8000 series units, and with each other
- Features Lyon T-Post Uprights and "Box W" shelf design

Color Selection

In Stock

DD Dove Gray

Also Available

PP Putty

BB Wedgewood Blue



**Five Shelf
Open Starter**



**Five Shelf
Open Add-On**



**Five Shelf
Closed Starter**



**Five Shelf
Closed Add-On**

No. of Shelves	12" Deep		18" Deep		24" Deep		12" Deep		18" Deep		24" Deep	
	Starters	Add-Ons	Starters	Add-Ons	Starters	Add-Ons	Starters	Add-Ons	Starters	Add-Ons	Starters	Add-Ons
	42" Wide OPEN Shelving Sections – 84" High 20-gauge, "Box W" Shelves						42" Wide CLOSED Shelving Sections – 84" High 20-gauge, "Box W" Shelves					
5	8046SH	8046H	8047SH	8047H	8048SH	8048H	8266SH	8266H	8267SH	8267H	8268SH	8268H
6	8056SH	8056H	8057SH	8057H	8058SH	8058H	8276SH	8276H	8277SH	8277H	8278SH	8278H
7	8066SH	8066H	8067SH	8067H	8068SH	8068H	8286SH	8286H	8287SH	8287H	8288SH	8288H
8	8073SH	8073H	8074SH	8074H	8075SH	8075H	8289SH	8289H	8290SH	8290H	8291SH	8291H

No. of Shelves	12" Deep		18" Deep		24" Deep		12" Deep		18" Deep		24" Deep	
	Starters	Add-Ons	Starters	Add-Ons	Starters	Add-Ons	Starters	Add-Ons	Starters	Add-Ons	Starters	Add-Ons
	48" Wide OPEN Shelving Sections – 84" High 20-gauge, "Box W" Shelves						48" Wide CLOSED Shelving Sections – 84" High 20-gauge, "Box W" Shelves					
5	8340SH	8340H	8341SH	8341H	8342SH	8342H	8334SH	8334H	8335SH	8335H	8336SH	8336H
6	8346SH	8346H	8347SH	8347H	8348SH	8348H	8331SH	8331H	8332SH	8332H	8333SH	8333H
7	8396SH	8396H	8397SH	8397H	8398SH	8398H	8391SH	8391H	8392SH	8392H	8393SH	8393H
8	8363SH	8363H	8364SH	8364H	8365SH	8365H	8343SH	8343H	8344SH	8344H	8345SH	8345H
	18-Gauge, "Box W" Shelves						18-gauge, "Box W" Shelves					
5	8340SX	8340X	8341SX	8341X	8342SX	8342X	8334SX	8334X	8335SX	8335X	8336SX	8336X
6	8346SX	8346X	8347SX	8347X	8348SX	8348X	8331SX	8331X	8332SX	8332X	8333SX	8333X
7	8396SX	8396X	8397SX	8397X	8398SX	8398X	8391SX	8391X	8392SX	8392X	8393SX	8393X
8	8363SX	8363X	8364SX	8364X	8365SX	8365X	8343SX	8343X	8344SX	8344X	8345SX	8345X

Pre-Engineered 8000 Series Shelving Sections with Galvanized Shelves

- Galvanized shelves deliver exceptional value and long life in harsh environments
- Ideal in areas subject to high humidity, or salt air in unheated warehouses
- Storing solvents, cleaning agents, oily or greasy parts and many other uses
- Sections are 36" wide x 84" high, with a choice of three depths
- Shelves are adjustable on 1 1/2" centers
- 18-Gauge traditional flanged shelves
- Only shelves are galvanized, not post



Note: Only shelves are galvanized.

Color Selection

In Stock

DD Dove Gray

Also Available

BB Wedgewood Blue

PP Putty

Six Shelf



Seven Shelf



Eight Shelf



Six Shelf



Seven Shelf



Eight Shelf



No. of Shelves	12" Deep (550 lb. Capacity*)		18" Deep (650 lb. Capacity*)		24" Deep (700 lb. Capacity*)	
	Starters	Add-Ons	Starters	Add-Ons	Starters	Add-Ons
Open Galvanized						
5	8005SGLV	8005GLV	8006SGLV	8006GLV	8007SGLV	8007GLV
6	8040SGLV	8040GLV	8041SGLV	8041GLV	8042SGLV	8042GLV
7	8030SGLV	8030GLV	8031SGLV	8031GLV	8032SGLV	8032GLV
8	8020SGLV	8020GLV	8021SGLV	8021GLV	8022SGLV	8022GLV
Closed Galvanized						
5	8037SGLV	8037GLV	8038SGLV	8038GLV	8039SGLV	8039GLV
6	8260SGLV	8260GLV	8261SGLV	8261GLV	8262SGLV	8262GLV
7	8090SGLV	8090GLV	8091SGLV	8091GLV	8092SGLV	8092GLV
8	8080SGLV	8080GLV	8081SGLV	8081GLV	8082SGLV	8082GLV

*Capacities are based on evenly distributed loads.



Pre-Engineered 8000 Series Wire Shelving Sections

- Wire shelf shelving maximizes air circulation, allows increased visibility, deters dust and dirt build-up, and provides for enhanced fire safety by allowing more sprinkler access through shelves from top to bottom
- All sections are 84" high, with a choice of two depths
- Shelves are adjustable on 1½" centers
- All steel components are Dove Gray



Five Shelf Open Starter



Five Shelf Open Add-On



Five Shelf Closed Starter



Five Shelf Closed Add-On

Photos for illustrative purposes only

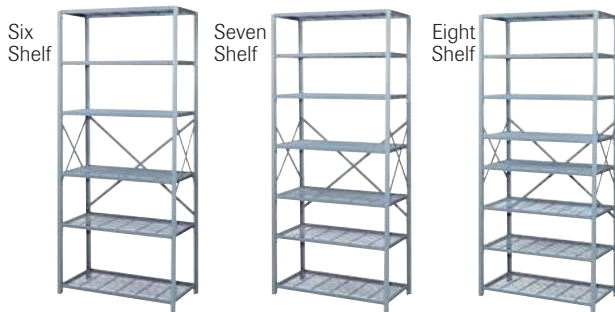

Photos for illustrative purposes only



Photos for illustrative purposes only

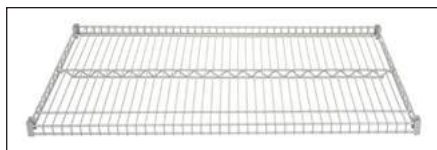

Features

Wire Shelves are all-welded, and constructed from heavy-gauge steel wire and heavy-gauge channels. Shelf load capacity ranges from 350 lbs.* (48" wide) to 500 lbs.* (36" wide) per shelf. Shelves slip easily onto uprights using Lyon shelf clips.

Photo represents actual wire shelf.

No. of Shelves	18" Deep		24" Deep		18" Deep		24" Deep	
	Starters	Add-Ons	Starters	Add-Ons	Starters	Add-Ons	Starters	Add-Ons
OPEN Wire Shelving Sections								
36" Wide Sections (Max. Cap.: 500 lbs. per shelf*)								
5	8006SWS	8006WS	8007SWS	8007WS	8038SWS	8038WS	8039SWS	8039WS
6	8041SWS	8041WS	8042SWS	8042WS	8261SWS	8261WS	8262SWS	8262WS
7	8031SWS	8031WS	8032SWS	8032WS	8091SWS	8091WS	8092SWS	8092WS
8	8021SWS	8021WS	8022SWS	8022WS	8081SWS	8081WS	8082SWS	8082WS
48" Wide Sections (Max. Cap.: 350 lbs. per shelf*)								
5	8341SWS	8341WS	8342SWS	8342WS	8335SWS	8335WS	8336SWS	8336WS
6	8347SWS	8347WS	8348SWS	8348WS	8332SWS	8332WS	8333SWS	8333WS
7	8397SWS	8397WS	8398SWS	8398WS	8392SWS	8392WS	8393SWS	8393WS
8	8364SWS	8364WS	8365SWS	8365WS	8344SWS	8344WS	8345SWS	8345WS

*Capacities based on evenly distributed loads.

36" Wide 8000 Series Counter Shelving



Note: Shown with optional finishing ends. See page 54-55 additional components and catalog numbers.

- Open counter shelving is ideal for packing, assembly and inspection work, where bin openings are not required
- Closed-counter design offers barrier-separations for partitioning off areas, plus concealed storage under the top
- Reinforced 14-gauge steel counter top
- All shelves are adjustable up or down on 1/2" centers
- Tops are 21 7/16" deep for 18" counters, and 27 7/16" deep for 24" counters

Shelf Type	36" w x 18" d x 39" h			36" w x 24" d x 39" h		
	Starter	Add-On	Capacity	Starter	Add-on	Capacity
3-Shelf Open Counter						
Heavy-Duty	8232SH	8232H	900 lbs.	8233SH	8233H	800 lbs.
Traditional	8232S	8232	650 lbs.	8233S	8233	700 lbs.
3-Shelf Closed Counter						
Heavy-Duty	8235SH	8235H	900 lbs.	8236SH	8236H	800 lbs.
Traditional	8235S	8235	650 lbs.	8236S	8236	700 lbs.
4-Shelf Closed Counter						
Heavy-Duty	8240SH	8240H	900 lbs.	8241SH	8241H	800 lbs.
Traditional	8240S	8240	650 lbs.	8241S	8241	700 lbs.



Steel Mounting Panel

- Easily add peg type storage on the end upright of 18" deep 8000 Series Shelving
 - Also great mounted on a wall, or on other type of rack
 - 5/16" diam. holes are punched every 1"
- No. 8210** – Steel Mounting Panel, Overall: 18" w x 42" h
No. 8200 – Tool Peg (50 per package)

No. 8038SWS Shelving Unit shown with two **No. 8210** Steel Mounting Panels

Color Selection

In Stock

DD Dove Gray

Also Available

PP Putty

BB Wedgewood Blue

Shown with Swinging Doors



Swinging Doors for 8000 Series Shelving

Transform your closed shelving sections into a lockable storage cabinet.

- Designed to retrofit the 36" w x 84" h closed 8000 Series Shelving
- Mounts directly to uprights in three places
- Right-hand swing door has chrome-plated handle, and a built-in key lock for extra security

Set of swinging doors only

No. 8837



8000 Series Shelving Accessories

- Add storage density to 8000 Series shelving with shelf boxes
- Choose steel, plastic or corrugated fiberboard to provide safe, systematic storage for small parts, tools and other items
- All are easily labeled for fast identification of contents and can be combined with modular drawers (pages 52-53) in shelving sections

Thrifty-Bin Corrugated Shelf Boxes

Makes a great economical alternative for storing small parts. Made of durable 200 lb. test fiberboard. Trimmed of waste and shipped flat. White only. Easy to assemble. Includes inventory control chart and large, convenient area for labeling. (Package of 100 boxes.)

For 12" Deep Shelving		For 18" Deep Shelving	
Cat. No.	W x D x H	Cat. No.	W x D x H
8352	2" x 11 ³ / ₄ " x 4 ¹ / ₂ "	8374	4" x 17 ³ / ₄ " x 4 ¹ / ₂ "
8353	3" x 11 ³ / ₄ " x 4 ¹ / ₂ "	8376	6" x 17 ³ / ₄ " x 4 ¹ / ₂ "
8354	4" x 11 ³ / ₄ " x 4 ¹ / ₂ "	8378	8" x 17 ³ / ₄ " x 4 ¹ / ₂ "
8356	6" x 11 ³ / ₄ " x 4 ¹ / ₂ "	8380	10" x 17 ³ / ₄ " x 4 ¹ / ₂ "
8358	8" x 11 ³ / ₄ " x 4 ¹ / ₂ "	8382	12" x 17 ³ / ₄ " x 4 ¹ / ₂ "
8360	10" x 11 ³ / ₄ " x 4 ¹ / ₂ "	N/A	N/A
8362	12" x 11 ³ / ₄ " x 4 ¹ / ₂ "	N/A	N/A

Shelf Dividers

Shelf space is determined by shelf divider height which attaches above and below shelves with push in fasteners, (included).



Description	12" Deep Cat. No.	18" Deep Cat. No.	24" Deep Cat. No.
1 ¹ / ₂ "h divider	N/A	8225	N/A
6"h divider	8620	8630	8640
9"h divider	8621	8631	8641
12"h divider	8622	8632	8642
15"h divider	8623	8633	8643
16 ¹ / ₂ "h divider	N/A	8635	N/A
18"h divider	8624	8634	8644

Additional Plastic Fasteners- No. 9P523

Label holders

- No. 8610 – for 36" w shelves
- No. 8611 – for 42" w shelves
- No. 832025 – for 48" w shelves

Label holder Spring Fastener

No. 8614 – For all 8000 Series Shelves

Labels (100 Pack)

No. 8615 – white

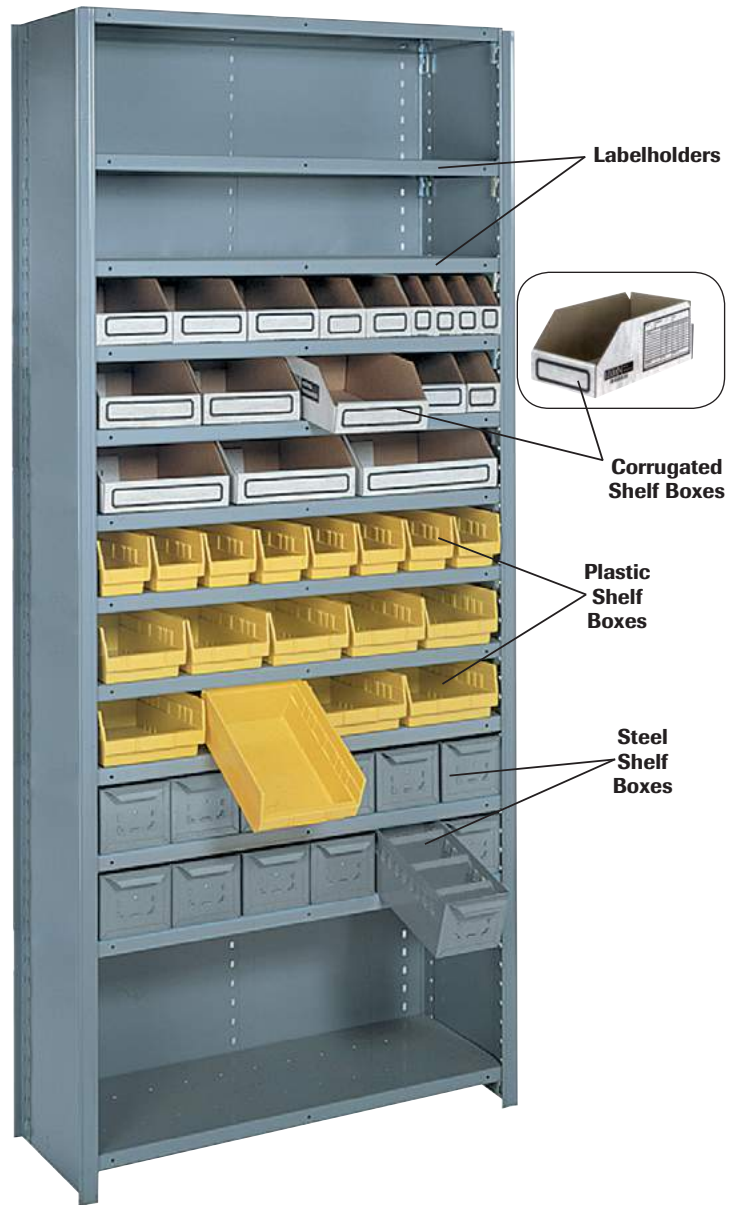

Color Selection

- In Stock**
- DD** Dove Gray
- Also Available**
- PP** Putty
- BB** Wedgewood Blue

8000 Series Shelving Accessories

Heavy-Duty Steel Shelf Boxes

Designed and manufactured for maximum durability!

Tough, steel boxes feature flanged backs that allow boxes to hang at an angle for 100% access. Sides are slotted for adjustable galvanized dividers (included). Integral label holders on front of each box make identification easy.



Standard 22 Ga. Shelf Boxes

Cat. No.	QTY	To Fit Shelves	W x D x H	Dividers included
8116	12 pk	12" Deep	5 ²¹ / ₃₂ " x 11 ¹ / ₄ " x 4 ⁵ / ₁₆ "	24
8117	12 pk	18" Deep	5 ²¹ / ₃₂ " x 17 ¹ / ₄ " x 4 ⁵ / ₁₆ "	36
8115	12 pk	24" Deep	5 ²¹ / ₃₂ " x 23 ¹ / ₄ " x 4 ⁵ / ₁₆ "	36
8118	100 pk	Extra Dividers for 8115, 8116, 8117 (galvanized finish)		

Color Selection

In Stock

DD Dove Gray

Also Available

PP Putty

Yellow Plastic Shelf Boxes

Durable, one-piece molded polypropylene is impervious to moisture, grease and oils. Sides and bottoms reinforced for added strength. Molded front handle includes 3" x 3/8" slot for labeling. Use up to 7 dividers in each box (available separately). Nest empty boxes to save space. Each box is 4" high. Yellow finish only.

**Plastic Shelf Boxes are imported.*



Outside	Inside	12"d		18"d		24"d		Qty. that fits on a 36"w shelf
		(10 ³ / ₈ " O.D. (I.D))	Qty	(16 ³ / ₄ " O.D. (I.D))	Qty	(22 ³ / ₈ " O.D. (I.D))	Qty	
4 ¹ / ₈ "	3 ⁵ / ₈ "	53124	24 pk	53184	12 pk	N/A	N/A	8
6 ⁵ / ₈ "	6 ¹ / ₈ "	53126	12 pk	53186	12 pk	53246	6 pk	5
8 ¹ / ₄ "	7 ³ / ₄ "	53128	12 pk	53188	12 pk	N/A	N/A	4

Plastic Bin Cups

Easily removed. Translucent plastic. Fit neatly into No. 53124 and No. 53184.

No. 53110 – 3³/₄"w x 2"d x 3"h – 48 pk

Plastic Dividers

Subdivide boxes to maximize inventory control. Black only.

No. 53104 – fits 53124 and 53184 – 24 pk

No. 53106 – fits 53126, 53186, 53246 – 24 pk

No. 53108 – fits 53128, 53188 – 24 pk

**Plastic Bin Cups and Plastic Dividers are imported.*



Modular Drawers for 36" Wide Shelving

- Increase storage density within 18" or 24" deep shelving sections with high density modular drawers for shelving to combine storage of bulky items and packaged stock with small parts, tools and supplies
- Modular drawers operate on smooth rolling ball-bearing suspension, which supports loads up to 400 lbs. per drawer
- Each drawer features ergonomic handles with removable labels and shields
- Existing 36" wide shelving can be retrofitted with modular drawers
- For single drawer installations, simply order No. 8901 Clips
- For multiple drawer installations (as in picture at right), you must order Drawer Guide Supports (see below)
- Partitions, dividers and other options are on opposite page
- Each drawer includes suspension equipment
- Guides simply hook into frame slots – then suspension units and drawers slide into place



How to Order

- 1) Determine depth of shelving.
- 2) Choose drawer guide support.
- 3) Choose combination of drawer heights to equal drawer guide support height.

W x D x H	Inside Height	Cat No.
For 18" Deep Shelving		
31 ¹¹ / ₁₆ " x 15 ³ / ₄ " x 3"	2"	8913
31 ¹¹ / ₁₆ " x 15 ³ / ₄ " x 4"	2 ¹ / ₂ "	8914
31 ¹¹ / ₁₆ " x 15 ³ / ₄ " x 5"	3 ¹ / ₂ "	8915
31 ¹¹ / ₁₆ " x 15 ³ / ₄ " x 6"	4 ¹ / ₂ "	8916
31 ¹¹ / ₁₆ " x 15 ³ / ₄ " x 7"	5 ¹ / ₂ "	8917
For 24" Deep Shelving		
31 ¹¹ / ₁₆ " x 21 ³ / ₄ " x 3"	2"	8933
31 ¹¹ / ₁₆ " x 21 ³ / ₄ " x 4"	2 ¹ / ₂ "	8934
31 ¹¹ / ₁₆ " x 21 ³ / ₄ " x 5"	3 ¹ / ₂ "	8935
31 ¹¹ / ₁₆ " x 21 ³ / ₄ " x 6"	4 ¹ / ₂ "	8936
31 ¹¹ / ₁₆ " x 21 ³ / ₄ " x 7"	5 ¹ / ₂ "	8937

Combination of drawer heights must equal drawer guide support height chosen.

Modular drawer installation should have a shelf directly above and below the drawer guide support as shown.

Color Selection

In Stock

DD Dove Gray

Also Available

PP Putty

BB Wedgewood Blue

ACCESSORIES AND RELATED PRODUCTS

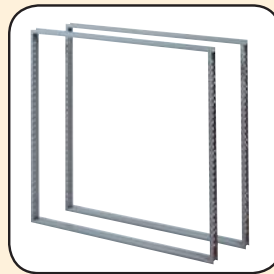

Drawer Guide Supports

- 1 set of 2 is needed to install 18", 32" or 36" high combination of modular drawers
- Supports bolt to shelving uprights
- Not needed when installing single drawer to single shelf
- One pair of finishing strips included with each set

No. 8905 – 18"h (22¹/₂" shelf spacing)

No. 8900 – 32"h, for counter high (37¹/₂" shelf spacing)

No. 8910 – 36"h (40¹/₂" shelf spacing)



Single Drawer Clips

Must be used when only one drawer is attached to one shelf.

No. 8901

Optional Accessories for Modular Drawers for 36" Wide Shelving

Pre-Engineered Modular Drawer Layouts

For use with Modular Drawers listed on opposite page. For other layouts, order partitions and dividers separately from listings below.

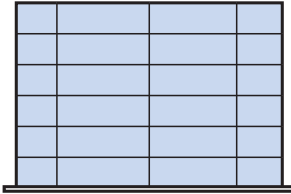

This layout includes:

- Three partitions
- Ten 6" w, ten 10" w dividers

Drawer Height	for 18"d Cat. No.	for 24"d Cat. No.
3"	8913-3	8933-3
4"	8914-3	8934-3
5"	8915-3	8935-3
6"	8916-3	8936-3
7"	8917-3	8937-3

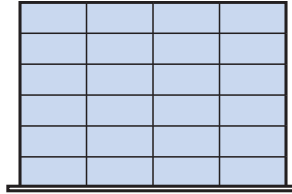

This layout includes:

- Three partitions
- Twenty 8" w dividers

Drawer Height	for 18"d Cat. No.	for 24"d Cat. No.
3"	8913-4	8933-4
4"	8914-4	8934-4
5"	8915-4	8935-4
6"	8916-4	8936-4
7"	8917-4	8937-4

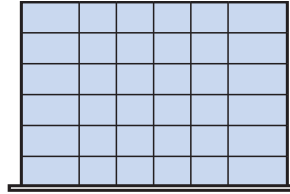

This layout includes:

- Five partitions
- Twenty 5" w, ten 6" w dividers

Drawer Height	for 18"d Cat. No.	for 24"d Cat. No.
3"	8913-7	8933-7
4"	8914-7	8934-7
5"	8915-7	8935-7
6"	N/A	N/A
7"	N/A	N/A

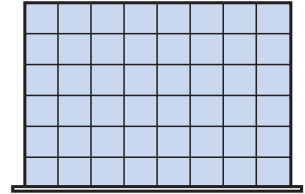

This layout includes:

- Seven partitions
- Forty 4" w dividers

Drawer Height	for 18"d Cat. No.	for 24"d Cat. No.
3"	8913-9	8933-9
4"	8914-9	8934-9
5"	8915-9	8935-9
6"	8916-9	8936-9
7"	8917-9	8937-9

Steel Partitions and Dividers

Form lengthwise (front to back) compartments in Modular Drawers on nominal 1" centers.

Available in Dove Gray and Natural Aluminum.

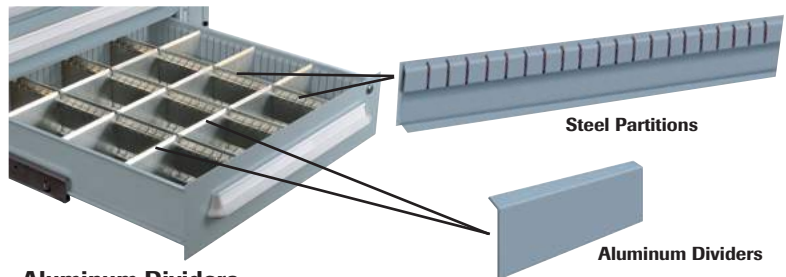

Steel Partitions

Aluminum Dividers

Steel Partitions

Slip into slots, and secured with a bolt.

Drawer Height	Partition Height	For 18"d Cat. No.	For 24"d Cat. No.
3"	1 ¹⁵ / ₁₆ "	8923	8943
4"	2 ⁷ / ₁₆ "	8924	8944
5"	3 ⁷ / ₁₆ "	8925	8945
6"/7"	4 ⁷ / ₁₆ "	8926	8946

Aluminum Dividers

Slip into partitions to create smaller compartments. Nominal width of dividers must equal 32".

Drawer Height	Divider Height	3" w Cat. No.	4" w Cat. No.	5" w Cat. No.	6" w Cat. No.	8" w Cat. No.	10" w Cat. No.
3"	1 ¹⁵ / ₁₆ "	8953	8954	8955	8956	8958	8959
4"	2 ⁷ / ₁₆ "	8963	8964	8965	8966	8968	8969
5"	3 ⁷ / ₁₆ "	N/A	8974	8975	8976	8978	8979
6"/7"	4 ⁷ / ₁₆ "	N/A	8984	N/A	8986	8988	8989

Removable Plastic Bins

Form lengthwise (front to back) compartments in Modular Drawers. Available in Yellow.

W x D x H	18"d/24"d Qty to fill depth	Divider for Bins	Cat. No.
3" x 3" x 2"	50/70	240332DIV	240332
3" x 6" x 2"	20/30	240332DIV	240362
6" x 6" x 2"	10/15	240662DIV	240662
3" x 3" x 3"	50/70	240333DIV	240333
3" x 6" x 3"	20/30	240333DIV	240363
6" x 6" x 3"	10/15	240663DIV	240663



*Plastic Bins and Plastic Dividers are imported.



How to Build an 8000 Series Shelving System

Step 1

Select Upright Assembly

Choose Open or Closed Upright
Determine depth and height of
Shelving Systems

Step 2

Select Back Bracing

Choose Lateral Cross Brace or
Solid Back Panel

Step 3

Select Shelves

Determine dimensions

Choose Gauge

Choose type-
Box "W" • Flanged • Wire •
Galvanized or Bin

Step 4

Select Accessories and/or Additional Components

Step 5

Select Anchoring and Additional Bracing Components

Foot Plate • Floor Angle • Anchor • End-Tie Clip

End-Tie Clip

(see step 5)

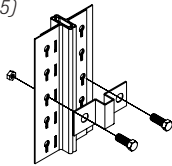

Anchoring System

(see step 5)

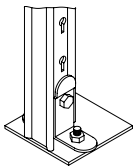

Step 1

Select Upright Assembly

(A) Open Shelving T-Post Upright Assembly

No. 8530 - 12"d x 84"h
No. 8536 - 18"d x 84"h
No. 8541 - 24"d x 84"h
No. 8531 - 12"d x 96"h
No. 8538 - 18"d x 96"h
No. 8542 - 24"d x 96"h
No. 8532 - 12"d x 120"h
No. 8539 - 18"d x 120"h
No. 8543 - 24"d x 120"h
No. 8841 - 30"d x 84"h

(B) Closed Shelving T-Post Upright Assembly

No. 8500 - 12"d x 84"h
No. 8506 - 18"d x 84"h
No. 8511 - 24"d x 84"h
No. 8501 - 12"d x 96"h
No. 8507 - 18"d x 96"h
No. 8512 - 24"d x 96"h
No. 8502 - 12"d x 120"h
No. 8508 - 18"d x 120"h
No. 8513 - 24"d x 120"h

Step 2

Select Back Bracing

(D) Open Lateral (Back) Cross Brace

No. 87901 - fits all 30"w & 36"w shelving including all counter shelving
No. 87911 - fits all 42"w shelving
No. 83301 - fits all 48"w shelving except counter shelving

Parts listed in single pack quantities, for multi-pack quantities,
contact Customer Service at 1-800-323-0082

(E) Shelving Backs

No. 86001 - 36"w x 39"h
No. 86011 - 36"w x 84"h
No. 86021 - 36"w x 96"h
No. 86031 - 36"w x 120"h
No. 86061 - 42"w x 84"h
No. 86071 - 42"w x 96"h
No. 86081 - 42"w x 120"h
No. 83161 - 48"w x 84"h
No. 86481 - 30"w x 84"h
No. 8882 - Additional Slotted Hex Head
Screws to attach shelving backs

Step 3

Select Shelves (All shelves include 4 clips)

(F) Medium Duty Shelves
22-Gauge Box "W"

(Without Label holder)

- No. 8560M1 - 36" w x 12" d
- No. 8561M1 - 36" w x 18" d
- No. 8562M1 - 36" w x 24" d

Heavy Duty Shelves
20-Gauge Box "W"

(Without Label holder)

- No. 8593H1 - 30" w x 30" d
- No. 8560H1 - 36" w x 12" d
- No. 8561H1 - 36" w x 18" d

- No. 8562H1 - 36" w x 24" d
- No. 8565H1 - 42" w x 12" d
- No. 8566H1 - 42" w x 18" d
- No. 8567H1 - 42" w x 24" d
- No. 8300H1 - 48" w x 12" d
- No. 8301H1 - 48" w x 18" d
- No. 8302H1 - 48" w x 24" d

Extra Heavy Duty Shelves
18-Gauge Box "W"

(Without Label holder)

- No. 8560X1 - 36" w x 12" d
- No. 8561X1 - 36" w x 18" d
- No. 8562X1 - 36" w x 24" d

- No. 8300X1 - 48" w x 12" d
- No. 8301X1 - 48" w x 18" d
- No. 8302X1 - 48" w x 24" d

(G) Traditional Shelves
18-Gauge Flanged†

(Without Label holder)

- No. 83001 - 48" w x 12" d
- No. 83011 - 48" w x 18" d
- No. 83021 - 48" w x 24" d
- No. 85601 - 36" w x 12" d
- No. 85611 - 36" w x 18" d
- No. 85621 - 36" w x 24" d

Bin Shelves

(see page 56)

Wire Shelves*

- No. 8561WS1N - 36" w x 18" d
- No. 8562WS1N - 36" w x 24" d
- No. 8301WS1N - 48" w x 18" d
- No. 8302WS1N - 48" w x 24" d

Galvanized Shelves

- No. 8560GLV1 - 36" w x 12" d
- No. 8561GLV1 - 36" w x 18" d
- No. 8562GLV1 - 36" w x 24" d

Parts listed in single pack quantities, for multi-pack quantities, contact Customer Service at 1-800-323-0082

Step 4

Accessories

(C) Open Rack End Cross Braces (2 pk)

- No. 85552 - for 12" d open rack ends
- No. 85562 - for 18" d open rack ends
- No. 85572 - for 24" d open rack ends
- No. 85582 - for 30" d open uprights
- No. 85592 - for 36" d open uprights

Roll-Formed T-Posts Only (2 pk)

- No. 8550 - 84" h
- No. 8551 - 96" h
- No. 8552 - 120" h

(H) 8000 Series Clips

- No. 8854 (Shelf Clip)
- No. 65160 (BSR Integration Clip)

(L) Bin Fronts (10 pk)

- No. 8755 - 36" w x 1" h
- No. 8756 - 36" w x 3" h
- No. 8757 - 42" w x 1" h
- No. 8758 - 42" w x 3" h
- No. 8324 - 48" w x 1" h
- No. 8325 - 48" w x 3" h

Back-to-Shelf Clips**

Tightens back to shelf

- No. 8850WS - for Wire shelves
- No. 8851 - for Flanged shelves
- No. 8853 - for Box "W" shelves
- Side-to-Back Clip
- No. 8850 - Connects T-Post to back

Base Shelf Clip

- No. 8807 - 1-1/2"
- Allows floor-level shelf with beaded post

(R) Base Strips (10 pk)

- No. 8765 - 36" w x 1-7/8" h
- No. 8766 - 36" w x 4-7/8" h
- No. 8767 - 42" w x 1-7/8" h
- No. 8768 - 42" w x 4-7/8" h
- No. 8327 - 48" w x 1-7/8" h

(J) Shelf Dividers (see page 50)

(V) Steel Shelf Boxes (see page 51)

Thrifty Bins (see page 50)

Label Holders (see page 50)

Swinging Doors for Shelving
(see page 49)

Step 5

Select Anchoring and Additional Bracing Components

Upright to Floor Angle

- No. 8859 - (4) per section of shelving

Footplate

- No. 8860 - 3" x 3" x 1/4" plate (1) per post

Anchor

- No. 8861 - 3/8" Dia. x 3" wedge anchor (1) per post

End-Tie Clip***

- No. 8856 - Ties sections back-to-back

Shim Plates (for uneven floors)

- No. 8852 - used w/out anchoring

- No. 8862 - 18-gauge used w/anchor
- No. 8863 - 14-gauge used w/anchor

- No. 8864 - 12-gauge used w/anchor

Arch Sway Brace 36"w

- No. 8809

Notes:

Shelving accessories can be used with both the T-Post or Offset Angle Post Uprights except where indicated.

Floor and/or wall anchoring is recommended for all shelving sections.

Lateral and end cross braces shown for illustrative purposes only. For quantities required and general erection instructions, see shelving installation instruction #9110-CA (included in standard packaged units). Installation must be level and plumb.

†Must request punching for bolting to uprights.

*Wire shelving sections with backs require Cat. No. 8850WS Back-to-Shelf Clip Item above.

**Not included with shelving backs. Order separately.

***2 per location at ends and every 3rd upright.



Pre-Engineered 8000 Series 36" Wide Bin Shelving

- Steel Bin Shelving is ideal where materials require assigned locations
- Shelf dividers are individually adjustable side-to-side on 3" centers
- Dividers can be removed or additional dividers added when your storage needs change
- To order extra dividers, see page 50
- Assembly required

Color Selection

In Stock

DD Dove Gray

Also Available

PP Putty

BB Wedgewood Blue

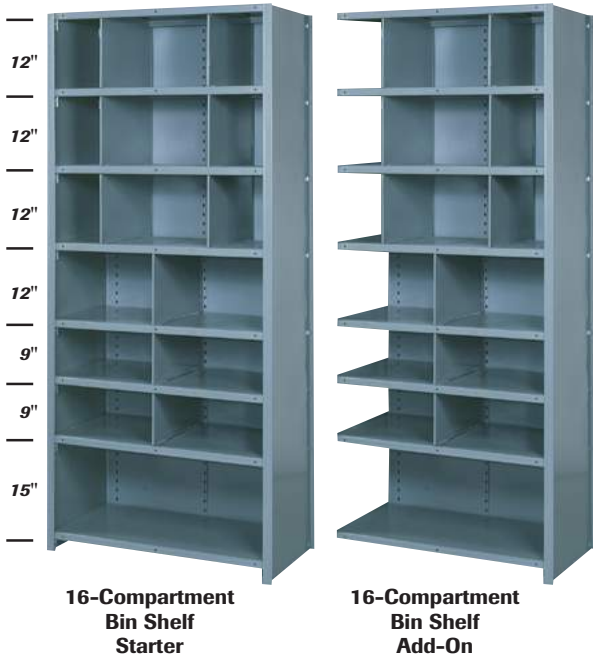

Get as many as 38 compartments, and all dividers can be adjusted to further customize the bin sizes!

W x D x H	Traditional Shelves			Heavy-Duty Shelves		
	Starter	Add-On	Capacity	Starter	Add-On	Capacity
16-Compartment Bin Shelf Unit						
36" x 12" x 84"	8060S	8060	750 lbs.	8060SH	8060H	800 lbs.
36" x 18" x 84"	8061S	8061	650 lbs.	8061SH	8061H	900 lbs.
36" x 24" x 84"	8062S	8062	700 lbs.	8062SH	8062H	800 lbs.
36-Compartment Bin Shelf Unit						
36" x 12" x 84"	8100S	8100	550 lbs.	8100SH	8100H	800 lbs.
36" x 18" x 84"	8101S	8101	650 lbs.	8101SH	8101H	900 lbs.
36" x 24" x 84"	8102S	8102	700 lbs.	8102SH	8102H	800 lbs.
38-Compartment Bin Shelf Unit						
36" x 12" x 84"	8120S	8120	650 lbs.	8120SH	8120H	800 lbs.
36" x 18" x 84"	8121S	8121	650 lbs.	8121SH	8121H	900 lbs.
36" x 24" x 84"	8122S	8122	700 lbs.	8122SH	8122H	800 lbs.

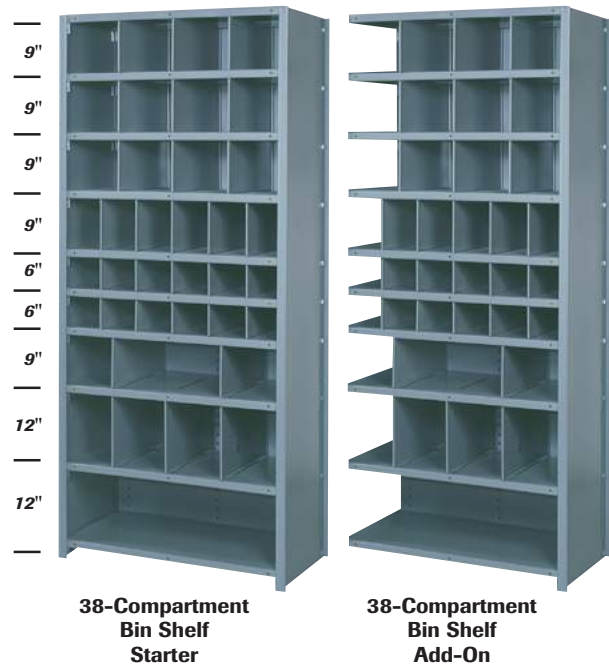
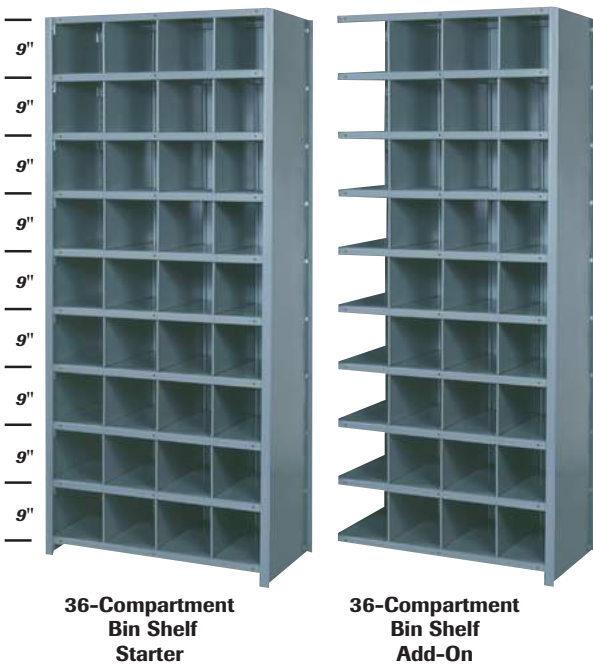

Stand Alone Offset Angle Shelving

Sturdy construction and easy installation make offset angle shelving ideal for applications calling for stand-alone sections.

- 13-gauge uprights utilize 8000 series 22-gauge "Box W" shelves for 36" w sections and 20-gauge "Box W" shelves for 48" w sections offering capacities of up to 600 lbs. per shelf. See page 44 for shelf capacities
- Open sections are great for cartoned or packaged stock providing high visibility
- Closed sections can serve as room dividers and offer protection from dust and sunlight
- Shelves adjust on 1½" centers using 8000 series shelf clips (nut and bolt top and bottom shelves for easy movement of empty sections)



Angle Uprights

Color Selection

- In Stock**
- DD** Dove Gray
- Also Available**
- PP** Putty
- BB** Wedgewood Blue

No. of Shelves	12" Deep	18" Deep	24" Deep	12" Deep	18" Deep	24" Deep
	36"W OPEN Shelving - 84" High			36"W CLOSED Shelving - 84" High		
5	8700M	8701M	8702M	8715M	8716M	8717M
6	8740M	8741M	8742M	8743M	8744M	8745M
7	8703M	8704M	8705M	8718M	8719M	8720M
8	8706M	8707M	8708M	8726M	8727M	8728M
9	8709M	8710M	8711M	8759M	8760M	8761M
10	8712M	8713M	8714M	8762M	8763M	8764M
Extra Shelf	8560M-1	8561M-1	8562M-1	8560M-1	8561M-1	8562M-1
	48"W OPEN Shelving - 84" High			48"W CLOSED Shelving - 84" High		
5	8440H	8441H	8442H	8460H	8461H	8462H
6	8443H	8444H	8445H	8463H	8464H	8465H
7	8446H	8447H	8448H	8466H	8467H	8468H
8	8449H	8450H	8451H	8469H	8470H	8471H
9	8452H	8453H	8454H	8472H	8473H	8474H
10	8455H	8456H	8457H	8475H	8476H	8477H
Extra Shelf	8300H-1	8301H-1	8302H-1	8300H-1	8301H-1	8302H-1

ACCESSORIES AND RELATED PRODUCTS

Open Shelving Offset Angle Upright Assembly (2pk)

- No. 87702 - 12"d x 84"h
- No. 87732 - 18"d x 84"h
- No. 87762 - 24"d x 84"h
- No. 87712 - 12"d x 96"h
- No. 87742 - 18"d x 96"h
- No. 87772 - 24"d x 96"h
- No. 87722 - 12"d x 120"h
- No. 87752 - 18"d x 120"h
- No. 87782 - 24"d x 120"h

Closed Shelving Offset Angle Upright Assembly (2pk)

- No. 87802 - 12"d x 84"h
- No. 87832 - 18"d x 84"h
- No. 87862 - 24"d x 84"h
- No. 87812 - 12"d x 96"h
- No. 87842 - 18"d x 96"h
- No. 87872 - 24"d x 96"h
- No. 87822 - 12"d x 120"h
- No. 87852 - 18"d x 120"h
- No. 87882 - 24"d x 120"h

Bolt-On Side Sheets Offset Angle Uprights Only (2pk)

- No. 87302 - 12"d x 84"h
- No. 87332 - 18"d x 84"h
- No. 87362 - 24"d x 84"h
- No. 87312 - 12"d x 96"h
- No. 87342 - 18"d x 96"h
- No. 87372 - 24"d x 96"h
- No. 87322 - 12"d x 120"h
- No. 87352 - 18"d x 120"h
- No. 87382 - 24"d x 120"h

Roll-Formed Offset Angle Uprights Only (need to order bracing - see below) (4pk)

- No. 8722 - 84"h
- No. 8723 - 96"h
- No. 8725 - 120"h

Open Rack End Cross Braces (2pk)

- No. 85552 - for 12"d
- No. 85562 - for 18"d
- No. 85572 - for 24"d

Open Lateral (Back) Cross Brace

- No. 87901 - fits all 36" w shelving
- No. 83301 - fits all 48" w shelving

For additional accessories see page 50 and 51.



Project Clip Shelving – Open Unit

Open shelving units are ideal for economical, general purpose storage. They allow light to penetrate a storage area and allow for free air flow around stored materials.

Standard side and back sway braces made from 12 gauge steel are used to stabilize open shelving units. Braces are punched to attach to upright posts with nuts and bolts.

Angle post units have angle posts on both front and rear corners. Beaded post units use beaded posts on front corners and angle posts on rear corners. Units include all necessary hardware.

Order one starter unit and the balance as adders to make up a row of shelving.

Shelving units ship K.D. (knocked down).



Color Selection

DD Dove Gray

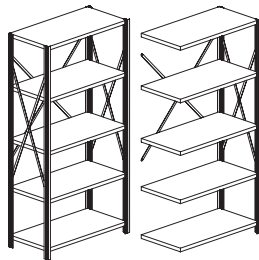
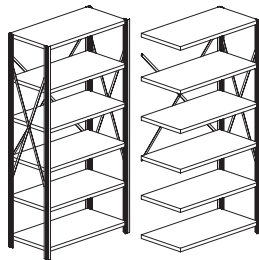
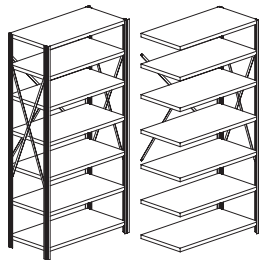
Open Units 85" High with Series 2000 Shelves								
Angle Post Unit			5 Shelves		6 Shelves		7 Shelves	
W	D	Capacity	Starter	Add-On	Starter	Add-On	Starter	Add-On
36"	12"	800#	JDP3001	JDP3004	JDP3013	JDP3016	JDP3025	JDP3028
36"	18"	850#	JDP3002	JDP3005	JDP3014	JDP3017	JDP3026	JDP3029
36"	24"	800#	JDP3003	JDP3006	JDP3015	JDP3018	JDP3027	JDP3030
42"	12"	600#	JDP3211	JDP3214	JDP3217	JDP3220	JDP3223	JDP3226
42"	18"	650#	JDP3212	JDP3215	JDP3218	JDP3221	JDP3224	JDP3227
42"	24"	650#	JDP2313	JDP3216	JDP3219	JDP3222	JDP3225	JDP3228
48"	12"	500#	JDP3101	JDP3104	JDP3113	JDP3116	JDP3125	JDP3128
48"	18"	550#	JDP3102	JDP3105	JDP3114	JDP3117	JDP3126	JDP3129
48"	24"	550#	JDP3103	JDP3106	JDP3115	JDP3118	JDP3127	JDP3130
Beaded Post Unit			5 Shelves		6 Shelves		7 Shelves	
W	D	Capacity	Starter	Add-On	Starter	Add-On	Starter	Add-On
36"	12"	800#	JDP3007	JDP3010	JDP3019	JDP3022	JDP3031	JDP3034
36"	18"	850#	JDP3008	JDP3011	JDP3020	JDP3023	JDP3032	JDP3035
36"	24"	800#	JDP3009	JDP3012	JDP3021	JDP3024	JDP3033	JDP3036
42"	12"	600#	JDP3261	JDP3264	JDP3267	JDP3270	JDP3273	JDP3276
42"	18"	650#	JDP3262	JDP3265	JDP3268	JDP3271	JDP3274	JDP3277
42"	24"	650#	JDP3263	JDP3266	JDP3269	JDP3272	JDP3275	JDP3278
48"	12"	500#	JDP3107	JDP3110	JDP3119	JDP3122	JDP3131	JDP3134
48"	18"	550#	JDP3108	JDP3111	JDP3120	JDP3123	JDP3132	JDP3135
48"	24"	550#	JDP3109	JDP3112	JDP3121	JDP3124	JDP3133	JDP3136

Order one starter unit and the balance as adders to make up a row of shelving.

Project Clip Shelving – Closed Unit

Closed shelving units are used for applications where stored materials require additional protection or containment. They utilize 24 gauge back and side sheets with the basic post/shelf connection for strength and stability. To improve the ease and speed of installation, upright assemblies can be used in place of individual posts and side sheets. End uprights are used at the beginning and end of rows. Intermediate uprights are used between units in a row. Two backs can be used when units exceed 8'1" in height; splices cover the seams on exposed two-piece backs.

The units shown feature Series 2000 heavy duty 20 gauge shelves for standard capacity requirements. Angle post units use angle posts on both front and rear corners. Beaded post units use beaded posts on front corners and angle posts on rear corners. Units are supplied with front bases to close off the unit below the bottom shelf. All necessary hardware is included.

Order one starter unit and the balance as adders to make up a row of shelving.

Shelving units ship K.D. (knocked down).



Color Selection

DD Dove Gray

Closed Units 85" High with Series 2000 Shelves								
			5 Shelves		6 Shelves		7 Shelves	
Angle Post Unit			Starter	Add-On	Starter	Add-On	Starter	Add-On
W	D	Capacity						
36"	12"	800#	JDP3049	JDP3052	JDP3061	JDP3064	JDP3073	JDP3076
36"	18"	850#	JDP3050	JDP3053	JDP3062	JDP3065	JDP3074	JDP3077
36"	24"	800#	JDP3051	JDP3054	JDP3063	JDP3066	JDP3075	JDP3078
42"	12"	600#	JDP3307	JDP3310	JDP3313	JDP3316	JDP3319	JDP3322
42"	18"	650#	JDP3308	JDP3311	JDP3314	JDP3317	JDP3320	JDP3323
42"	24"	650#	JDP3309	JDP3312	JDP3315	JDP3318	JDP3321	JDP3324
48"	12"	500#	JDP3149	JDP3152	JDP3161	JDP3164	JDP3173	JDP3176
48"	18"	550#	JDP3150	JDP3153	JDP3162	JDP3165	JDP3174	JDP3177
48"	24"	550#	JDP3151	JDP3154	JDP3163	JDP3166	JDP3175	JDP3178
Beaded Post Unit			5 Shelves		6 Shelves		7 Shelves	
W	D	Capacity	Starter	Add-On	Starter	Add-On	Starter	Add-On
36"	12"	800#	JDP3055	JDP3058	JDP3067	JDP3070	JDP3079	JDP3082
36"	18"	850#	JDP3056	JDP3059	JDP3068	JDP3071	JDP3080	JDP3083
36"	24"	800#	JDP3057	JDP3060	JDP3069	JDP3072	JDP3081	JDP3084
42"	12"	600#	JDP3331	JDP3334	JDP3337	JDP3340	JDP3343	JDP3346
42"	18"	650#	JDP3332	JDP3335	JDP3338	JDP3341	JDP3344	JDP3347
42"	24"	650#	JDP3333	JDP3336	JDP3339	JDP3342	JDP3345	JDP3348
48"	12"	500#	JDP3155	JDP3158	JDP3167	JDP3170	JDP3179	JDP3182
48"	18"	550#	JDP3156	JDP3159	JDP3168	JDP3171	JDP3180	JDP3183
48"	24"	550#	JDP3157	JDP3160	JDP3169	JDP3172	JDP3181	JDP3184

Order one starter unit and the balance as adders to make up a row of shelving.



Project Clip Shelving – Components

Upright posts for clip shelving units are available in angle, beaded and heavy duty styles to meet a variety of uses. Angle posts are the most economical design, while beaded posts offer clear shelf access. For additional capacity, choose heavy duty posts with a rectangular tube design. Heavy duty posts provide up to four times the capacities of angle and beaded posts.

Available in lengths up to 17'1", posts are roll formed from 14 gauge steel for maximum strength and feature 1-1/2" vertical shelf adjustment. Post splices for all styles can be used for high-rise and multi-level shelving applications.



Angle

Beaded

Heavy Duty

Series 2000 shelves are available in extra heavy duty, heavy duty and medium duty construction (18, 20 or 22 gauge) to meet a wide range of capacity requirements. Sizes range from 24" to 60" wide and 9" to 36" deep. For custom applications, the width dimension is fully adjustable to match specific storage requirements.

Series 2000 shelves are roll formed with box formations in the front and rear of the shelf for high capacity ratings, without additional reinforcing.

Compression clips are formed from heavy 13 gauge steel for maximum strength. They engage square holes on upright posts to form a secure

support for the shelf. As weight is added to the shelf, compression increases to transfer the load to the posts.

Standard side and back sway braces made from 12 gauge steel are used to stabilize open shelving units. Braces are punched to attach to upright posts with nuts and bolts.

Allowable Shelf Loads - ANSI MH 28.1			
Series 2000			
Shelf Size	18 gauge	20 gauge	22 gauge
24" x 12"	--	850	500
24" x 18"	--	750	500
24" x 24"	--	600	500
30" x 12"	--	850	500
30" x 18"	--	800	500
30" x 24"	--	700	500
36" x 12"	1100	800	500
36" x 15"	1100	825	500
36" x 18"	1200	850	500
36" x 24"	1250	800	550
36" x 30"	900	600	450
36" x 36"	900	550	350
42" x 12"	900	600	330
42" x 15"	900	600	330
42" x 18"	950	650	355
42" x 24"	1000	650	355
42" x 30"	1000	625	340
42" x 32"	950	600	330
42" x 36"	900	550	300
48" x 12"	750	500	275
48" x 15"	850	525	285
48" x 18"	900	550	300
48" x 24"	900	550	300
48" x 30"	750	525	285
48" x 36"	750	500	275
54" x 18"	750	480	--
54" x 24"	750	480	--
54" x 30"	650	460	--
54" x 32"	650	460	--
54" x 36"	600	430	--
60" x 18"	600	420	--
60" x 30"	560	400	--
60" x 36"	500	375	--

* Loads are limited by the ANSI MH 28.1-1997 safety factor of 1.5.
Do not exceed uniformly distributed loads shown. Concentrated load points or impact (dropped) loads could cause shelf failure even though the impact load is less than allowable load shown.

Nominal Growth Illustration Chart - Project Clip Shelving

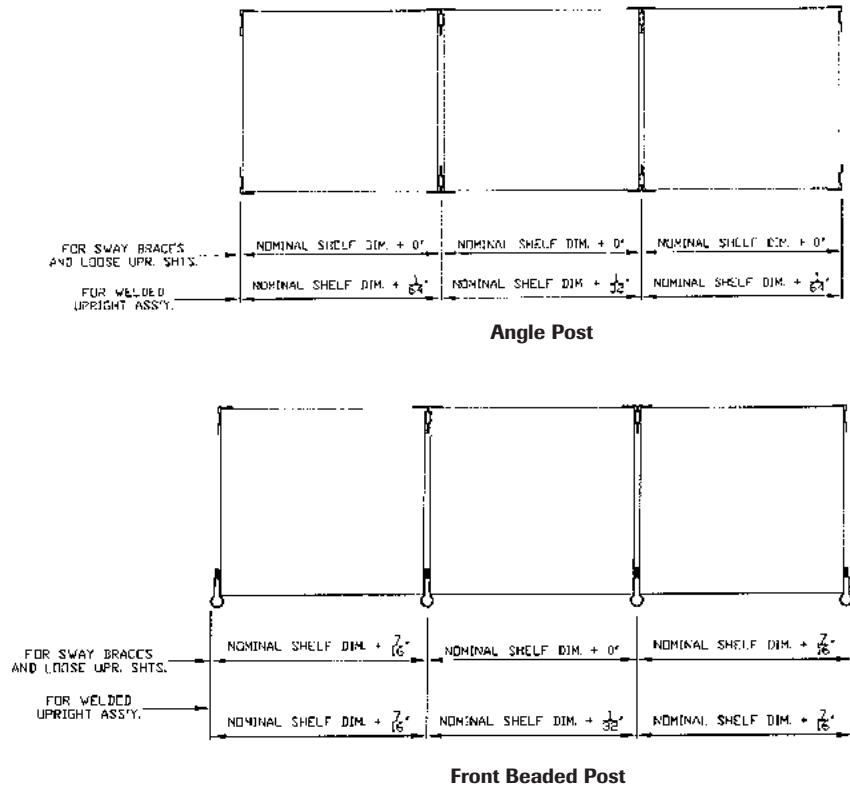

Project Clip Shelving – Components

Item	Cat. No.	Package Qty
Angle Post		
7'1" H	J1000491	1 pk
8'1" H	J1000571	1 pk
10'1" H	J1000731	1 pk
Splice	J1992201	1 pk
Beaded Post		
7'1" H	J1070491	1 pk
8'1" H	J1070571	1 pk
10'1" H	J1070731	1 pk
Splice	J1992191	1 pk
Foot Plate - Angle & Beaded Post		
2-1/8" x 2-7/8"	J1937011	1 pk
Sway Braces for Units		
12", 24" D	J1068221	1 pk
18", 24" D	J1068231	1 pk
36" W	J1068241	1 pk
42", 48" W	J1068251	1 pk
12", 24" D	J1068222	2 pk
18", 24" D	J1068232	2 pk
36" W	J1068242	2 pk
42", 48" W	J1068252	2 pk
12", 24" D	J1068220	20 pk
18", 24" D	J1068230	20 pk
36" W	J1068240	20 pk
42", 48" W	J1068250	20 pk
Sway Braces		
For Angle Posts	J1937001	1 pk
For Beaded Posts	J1968661	1 pk
Back		
36" W x 4'1" H	J1051711	1 pk
36" W x 5'1" H	J1051791	1 pk
36" W x 7'1" H	J1051951	1 pk
48" W x 4'1" H	J1053171	1 pk
48" W x 5'1" H	J1053251	1 pk
48" W x 7'1" H	J1053411	1 pk
36" W x 4'1" H	J1051718	8 pk
36" W x 5'1" H	J1051796	6 pk
36" W x 7'1" H	J1051954	4 pk
48" W x 4'1" H	J1053176	6 pk
48" W x 5'1" H	J1053255	5 pk
48" W x 7'1" H	J1053414	4 pk

Item	Cat. No.	Package Qty
Side Sheet		
12" D x 4'1" H	J1010981	1 pk
12" D x 5'1" H	J1011061	1 pk
12" D x 7'1" H	J1011221	1 pk
18" D x 4'1" H	J1012441	1 pk*
18" D x 5'1" H	J1012521	1 pk*
18" D x 7'1" H	J1012681	1 pk
18" D x 7'1" H	J1012686	6 pk
24" D x 4'1" H	J1013171	1 pk*
24" D x 5'1" H	J1013251	1 pk*
24" D x 7'1" H	J1013411	1 pk
24" D x 7'1" H	J1013416	6 pk
Welded End Upright Assembly (Beaded Post)		
12" D x 7'1" H	J1073221	1 pk
18" D x 7'1" H	J1074681	1 pk
24" D x 7'1" H	J1075411	1 pk
12" D x 7'1" H	J1073224	4 pk
18" D x 7'1" H	J1074684	4 pk
24" D x 7'1" H	J1075414	4 pk
Welded End Upright Assembly (Angle Post)		
12" D x 7'1" H	J1083221	1 pk
18" D x 7'1" H	J1084681	1 pk
24" D x 7'1" H	J1085411	1 pk
12" D x 7'1" H	J1083224	4 pk
18" D x 7'1" H	J1084684	4 pk
24" D x 7'1" H	J1085414	4 pk
Series 2000 - 18 ga. Shelves		
48" W x 18" D	J1022191	1 pk
48" W x 24" D	J1022241	1 pk
48" W x 18" D	J1022195	5 pk
48" W x 24" D	J1022245	5 pk
Series 2000 - 20 ga. Shelves		
36" W x 12" D	J1021071	1 pk
36" W x 18" D	J1021171	1 pk
36" W x 24" D	J1021221	1 pk
42" W x 18" D	J1021181	1 pk
48" W x 12" D	J1021091	1 pk
48" W x 18" D	J1021191	1 pk
48" W x 24" D	J1021241	1 pk

*Non-stock item. Please contact Customer Service at 1-800-323-0082 for availability.

Item	Cat. No.	Package Qty
Series 2000 - 20 ga. Shelves (continued)		
36" W x 12" D	J1021075	5 pk
36" W x 18" D	J1021175	5 pk
36" W x 24" D	J1021225	5 pk
42" W x 18" D	J1021185	5 pk
48" W x 12" D	J1021095	5 pk
48" W x 18" D	J1021195	5 pk
48" W x 24" D	J1021245	5 pk
Series 2000 - 22 ga. Shelves		
36" W x 12" D	J1020071	1 pk
36" W x 18" D	J1020171	1 pk
36" W x 24" D	J1020221	1 pk
36" W x 12" D	J1020075	5 pk
36" W x 18" D	J1020175	5 pk
36" W x 24" D	J1020225	5 pk
Front Base (for Angle Post)		
36" W x 3" H	J1079781	1 pk
48" W x 3" H	J1079801	1 pk
36" W x 3" H	J1079785	5 pk
48" W x 3" H	J1079805	5 pk
36" W x 3" H	J10797820	20 pk
48" W x 3" H	J10798020	20 pk
Front Base (for Beaded Post)		
36" W x 3" H	J1079981	1 pk
48" W x 3" H	J1080001	1 pk
36" W x 3" H	J1079985	5 pk
48" W x 3" H	J1080005	5 pk
36" W x 3" H	J10799820	20 pk
48" W x 3" H	J10800020	20 pk
Clips (supplied with shelves)		
Shelf Clip	J193719	1 pk
Half Shelf Clip	J193728	1 pk

Shelf Spacing	Post Load Table - ANSI MH 28.1 - 1982			
	Single Angle	Double Angle	Beaded	Heavy Duty
	Allowable Axial (Vertical) Load (lbs.) Per Post Type			
12"	2100	4600	4800	7900
18"	1900	4400	4400	7800
24"	1500	4100	3800	7600
36"	800	3200	2200	7000
42"	600	2600	1600	6600
48"	- -	2000	- -	6200
30"	1100	3700	3100	7300

All components are available from stock in Dove Gray. Contact Lyon for additional sizes.

Post capacities are dependent upon shelf spacing. The carrying capacity of a post increases as shelf spacing decreases. Do not exceed the allowable loads listed.



Designed for the hand-loading of intermediate weight bulky items. In addition to storing cartoned merchandise, it can be used for display racking. Heavy-duty 14-gauge steel beams included. For specifications on individual components, see pages 64-67.



Starter with No Decking
Front-To-Back supports per level:
60"w-1, 72", 84", 96"w-2



Starter with Solid Decking
Front-To-Back supports per level:
60"w-1, 72", 84", 96"w-2



Starter with Ribbed Decking
Front-To-Back supports per level:
60"w-1, 72", 84", 96"w-2

Color Selection

In Stock

DD Dove Gray

Also Available

PP Putty

Levels	Height	Depth	Type	60" Wide Racks					72" Wide Racks				
				No Deck	Solid	Ribbed	H.D. Wire	Particle	No Deck	Solid	Ribbed	H.D. Wire	Particle
3	60"	24"	Starter	67201S	N/A	67201SR	67201SW	67201SP	67301S	67301SD	67301SR	67301SW	67301SP
			Add-on	67201	N/A	67201R	67201W	67201P	67301	67301D	67301R	67301W	67301P
		30"	Starter	67202S	67202SD	67202SR	67202SW	N/A	67302S	N/A	67302SR	67302SW	N/A
			Add-on	67202	67202D	67202R	67202W	N/A	67302	N/A	67302R	67302W	N/A
		36"	Starter	67203S	67203SD	67203SR	67203SW	67203SP	67303S	67303SD	67303SR	67303SW	67303SP
			Add-on	67203	67203D	67203R	67203W	67203P	67303	67303D	67303R	67303W	67303P
		48"	Starter	67205S	67205SD	67205SR	67205SW	67205SP	67305S	67305SD	67305SR	67305SW	67305SP
			Add-on	67205	67205D	67205R	67205W	67205P	67305	67305D	67305R	67305W	67305P
3	72"	24"	Starter	67211S	N/A	67211SR	67211SW	67211SP	67311S	67311SD	67311SR	67311SW	67311SP
			Add-on	67211	N/A	67211R	67211W	67211P	67311	67311D	67311R	67311W	67311P
		30"	Starter	67212S	67212SD	67212SR	67212SW	N/A	67312S	N/A	67312SR	67312SW	N/A
			Add-on	67212	67212D	67212R	67212W	N/A	67312	N/A	67312R	67312W	N/A
		36"	Starter	67213S	67213SD	67213SR	67213SW	67213SP	67313S	67313SD	67313SR	67313SW	67313SP
			Add-on	67213	67213D	67213R	67213W	67213P	67313	67313D	67313R	67313W	67313P
		48"	Starter	67215S	67215SD	67215SR	67215SW	67215SP	67315S	67315SD	67315SR	67315SW	67315SP
			Add-on	67215	67215D	67215R	67215W	67215P	67315	67315D	67315R	67315W	67315P
3	84"	24"	Starter	67221S	N/A	67221SR	67221SW	67221SP	67321S	67321SD	67321SR	67321SW	67321SP
			Add-on	67221	N/A	67221R	67221W	67221P	67321	67321D	67321R	67321W	67321P
		30"	Starter	67222S	67222SD	67222SR	67222SW	N/A	67322S	N/A	67322SR	67322SW	N/A
			Add-on	67222	67222D	67222R	67222W	N/A	67322	N/A	67322R	67322W	N/A
		36"	Starter	67223S	67223SD	67223SR	67223SW	67223SP	67323S	67323SD	67323SR	67323SW	67323SP
			Add-on	67223	67223D	67223R	67223W	67223P	67323	67323D	67323R	67323W	67323P
		48"	Starter	67225S	67225SD	67225SR	67225SW	67225SP	67325S	67325SD	67325SR	67325SW	67325SP
			Add-on	67225	67225D	67225R	67225W	67225P	67325	67325D	67325R	67325W	67325P
4	96"	24"	Starter	67231S	N/A	67231SR	67231SW	67231SP	67331S	67331SD	67331SR	67331SW	67331SP
			Add-on	67231	N/A	67231R	67231W	67231P	67331	67331D	67331R	67331W	67331P
		30"	Starter	67232S	67232SD	67232SR	67232SW	N/A	67332S	N/A	67332SR	67332SW	N/A
			Add-on	67232	67232D	67232R	67232W	N/A	67332	N/A	67332R	67332W	N/A
		36"	Starter	67233S	67233SD	67233SR	67233SW	67233SP	67333S	67333SD	67333SR	67333SW	67333SP
			Add-on	67233	67233D	67233R	67233W	67233P	67333	67333D	67333R	67333W	67333P
		48"	Starter	67235S	67235SD	67235SR	67235SW	67235SP	67335S	67335SD	67335SR	67335SW	67335SP
			Add-on	67235	67235D	67235R	67235W	67235P	67335	67335D	67335R	67335W	67335P

NOTE: In the interest of safety, Lyon strongly recommends that racks that are 72" or higher be floor and/or wall anchored. See page 72 for important anchoring information.



Starter with Waterfall H. D. Wire Decking
Front-To-Back supports per level:
60"w-1, 72", 84", 96"w-2



Starter with Particle Board
Front-To-Back supports per level:
60"w-2, 72"w-3, 96"w-4

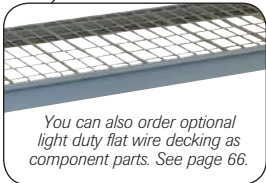

You can also order optional light duty flat wire decking as component parts. See page 66.

1 Bulk Storage Racks integrates seamlessly with 8000 Series shelving for a complete storage system.

8000 Series/BSR Integration Clip
No. 65160

Levels	Height	Depth	Type	84" Wide Racks					96" Wide Racks				
				No Deck	Solid	Ribbed	H.D. Wire	Particle	No Deck	Solid	Ribbed	H.D. Wire	Particle
3	60"	24"	Starter	67401S	67401SD	67401SR	67401SW	N/A	67501S	67501SD	67501SR	67501SW	67501SP
			Add-on	67401	67401D	67401R	67401W	N/A	67501	67501D	67501R	67501W	67501P
		30"	Starter	67402S	N/A	67402SR	67402SW	N/A	67502S	N/A	67502SR	67502SW	N/A
			Add-on	67402	N/A	67402R	67402W	N/A	67502	N/A	67502R	67502W	N/A
		36"	Starter	67403S	67403SD	67403SR	67403SW	N/A	67503S	67503SD	67503SR	67503SW	67503SP
			Add-on	67403	67403D	67403R	67403W	N/A	67503	67503D	67503R	67503W	67503P
		48"	Starter	67405S	67405SD	67405SR	67405SW	N/A	67505S	67505SD	67505SR	67505SW	67505SP
			Add-on	67405	67405D	67405R	67405W	N/A	67505	67505D	67505R	67505W	67505P
3	72"	24"	Starter	67411S	67411SD	67411SR	67411SW	N/A	67511S	67511SD	67511SR	67511SW	67511SP
			Add-on	67411	67411D	67411R	67411W	N/A	67511	67511D	67511R	67511W	67511P
		30"	Starter	67412S	N/A	67412SR	67412SW	N/A	67512S	N/A	67512SR	67512SW	N/A
			Add-on	67412	N/A	67412R	67412W	N/A	67512	N/A	67512R	67512W	N/A
		36"	Starter	67413S	67413SD	67413SR	67413SW	N/A	67513S	67513SD	67513SR	67513SW	67513SP
			Add-on	67413	67413D	67413R	67413W	N/A	67513	67513D	67513R	67513W	67513P
		48"	Starter	67415S	67415SD	67415SR	67415SW	N/A	67515S	67515SD	67515SR	67515SW	67515SP
			Add-on	67415	67415D	67415R	67415W	N/A	67515	67515D	67515R	67515W	67515P
3	84"	24"	Starter	67421S	67421SD	67421SR	67421SW	N/A	67521S	67521SD	67521SR	67521SW	67521SP
			Add-on	67421	67421D	67421R	67421W	N/A	67521	67521D	67521R	67521W	67521P
		30"	Starter	67422S	N/A	67422SR	67422SW	N/A	67522S	N/A	67522SR	67522SW	N/A
			Add-on	67422	N/A	67422R	67422W	N/A	67522	N/A	67522R	67522W	N/A
		36"	Starter	67423S	67423SD	67423SR	67423SW	N/A	67523S	67523SD	67523SR	67523SW	67523SP
			Add-on	67423	67423D	67423R	67423W	N/A	67523	67523D	67523R	67523W	67523P
		48"	Starter	67425S	67425SD	67425SR	67425SW	N/A	67525S	67525SD	67525SR	67525SW	67525SP
			Add-on	67425	67425D	67425R	67425W	N/A	67525	67525D	67525R	67525W	67525P
4	96"	24"	Starter	67431S	67431SD	67431SR	67431SW	N/A	67531S	67531SD	67531SR	67531SW	67531SP
			Add-on	67431	67431D	67431R	67431W	N/A	67531	67531D	67531R	67531W	67531P
		30"	Starter	67432S	N/A	67432SR	67432SW	N/A	67532S	N/A	67532SR	67532SW	N/A
			Add-on	67432	N/A	67432R	67432W	N/A	67532	N/A	67532R	67532W	N/A
		36"	Starter	67433S	67433SD	67433SR	67433SW	N/A	67533S	67533SD	67533SR	67533SW	67533SP
			Add-on	67433	67433D	67433R	67433W	N/A	67533	67533D	67533R	67533W	67533P
		48"	Starter	67435S	67435SD	67435SR	67435SW	N/A	67535S	67535SD	67535SR	67535SW	67535SP
			Add-on	67435	67435D	67435R	67435W	N/A	67535	67535D	67535R	67535W	67535P

NOTE: In the interest of safety, Lyon strongly recommends that racks that are 72" or higher be floor and/or wall anchored. See page 72 for important anchoring information.



Step 1

Select Upright Assembly (see page 65)

Select Uprights by size in either fully welded set-up or knocked down

Step 2

Select Beam (see page 65)

Select Beam based on width of opening and weight capacity needed:

- Heavy and Extra Heavy-Duty "Z" Beams
- Low-Profile Beams

Step 3

Select Decking (see page 66)

Select Decking based on size and style desired:

- Solid Decking
- Particle Board Decking
- Ribbed Decking
- Wire Decking

Step 4

Select Front-to-Back Supports (see page 67)

Select Front-To-Back Support based on depth of upright and decking

Step 5

Select Accessories (see page 67)



Color Selection

In Stock

DD Dove Gray

Also Available

PP Putty

1 DIMENSIONS FOR BULK STORAGE RACKS

When figuring floor space for Lyon bulk storage racks, first add 4 7/8" to nominal beam length for width of single section.

Next, add 2 15/16" to nominal beam length for each additional section.

Then, add 9/16" to nominal depth of upright assembly.

Also, racks must be level and plumb and installed per assembly instruction #10206-AA.

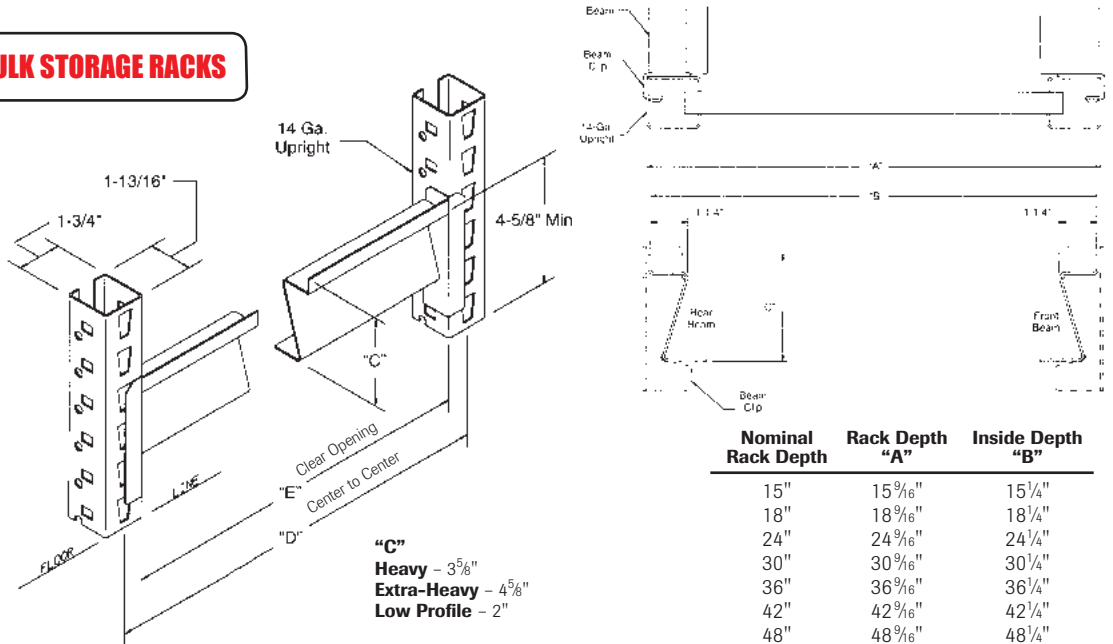

Capacities shown are maximum safe evenly distributed static loads per pair of beams with front-to-back support. Upright capacities are based on beam centers no greater than 36".



Step 1

Select Upright Assembly

Choose All-Welded or K.D.

- Welded Upright has tubular bracing, mig-welded to post
- K.D. (knocked down) Upright includes two posts and two or more bolt on ladder braces
 - Upright: 1³/₄" x 1¹³/₁₆"
 - 14-gauge
 - Adjustment on 1¹/₂" centers
- 10,000 lb. capacity per section (All-Welded or K.D.)

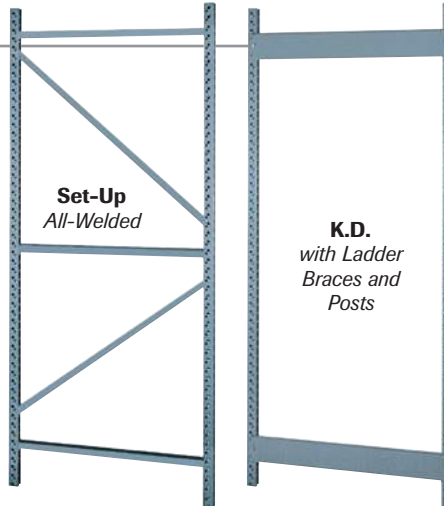

K.D. Ladder Braces Only

Use as replacement, or as a component

K.D. Upright Posts Only

Height	Cat. No.
60"	63602
72"	63603
84"	63604
96"	63605
120"	63607
144"	63609

Depth	Cat. No.
15"	635152
18"	635182
24"	635242
30"	635302
36"	635362
42"	635422
48"	635482

Depth	60" High		72" High		84" High		96" High		120" High		144" High	
	Set-Up Cat. No.	K.D. Cat. No.	Set-Up Cat. No.	K.D. Cat. No.	Set-Up Cat. No.	K.D. Cat. No.	Set-Up Cat. No.	K.D. Cat. No.	Set-Up Cat. No.	K.D. Cat. No.	Set-Up Cat. No.	K.D. Cat. No.
15"	N/A	63152	N/A	63153	N/A	63154	N/A	63155	N/A	63157	N/A	63159
18"	N/A	63182	N/A	63183	N/A	63184	N/A	63185	N/A	63187	N/A	63189
24"	64242	63242	64243	63243	64244	63244	64245	63245	64247	63247	64249	63249
30"	64302	63302	64303	63303	64304	63304	64305	63305	64307	63307	64309	63309
36"	64362	63362	64363	63363	64364	63364	64365	63365	64367	63367	64369	63369
42"	64422	63422	64423	63423	64424	63424	64425	63425	64427	63427	64429	63429
48"	64482	63482	64483	63483	64484	63484	64485	63485	64487	63487	64489	63489

Step 2

Select Beams

• Heavy and Extra Heavy-Duty "Z" Beams

Unique "Z" beam design increases strength and load capacity, resists tipping and eliminates wasted space, front-to-back. Beam clips are mig-welded for added strength. Fold in lock tab easily engages for security against displacement.

• Low-Profile Beams

Offer light weight, high-density alternative for commercial applications. Narrow height design increases vertical storage capacity.

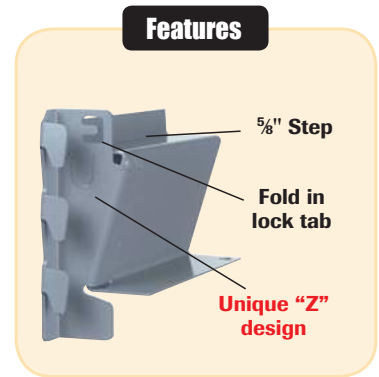
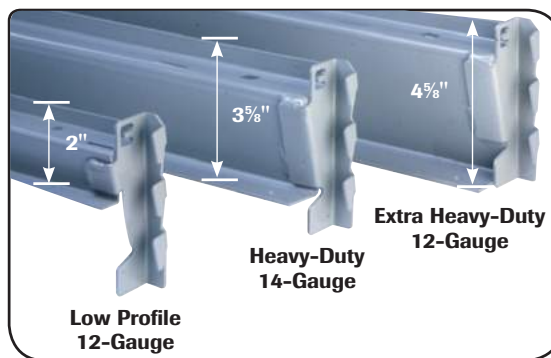

Note: The catalog numbers in the chart below are sold as 2 packs

Nominal Width	Actual Width	"D"	"E"	Heavy-Duty 14-Gauge		Extra-Heavy Duty 12-Gauge		Low Profile 12-Gauge	
				Cat. No.	Capacity	Cat. No.	Capacity	Cat. No.	Capacity
48"	48 ¹ / ₂ "	50 ¹⁵ / ₃₂ "	48 ²³ / ₃₂ "	62148	3,300 lbs.	*	*	62048	665 lbs.
60"	60 ¹ / ₂ "	62 ¹⁵ / ₃₂ "	60 ²³ / ₃₂ "	62160	2,600 lbs.	*	*	62060	530 lbs.
72"	72 ¹ / ₂ "	74 ¹⁵ / ₃₂ "	72 ²³ / ₃₂ "	62172	1,900 lbs.	62272	3,300 lbs.	62072	440 lbs.
84"	84 ¹ / ₂ "	86 ¹⁵ / ₃₂ "	84 ²³ / ₃₂ "	62184	1,775 lbs.	*	*	62084	380 lbs.
96"	96 ¹ / ₂ "	98 ¹⁵ / ₃₂ "	96 ²³ / ₃₂ "	62196	1,650 lbs.	62296	3,300 lbs.	62096	330 lbs.

Capacities shown are maximum safe evenly distributed static loads per pair of beams with front-to-back support. Upright capacities are based on beam centers no greater than 36".
*Items available through manufactured schedule.



Step 3

Select Decking

Two to three panels per level are required based on beam width (see chart below).

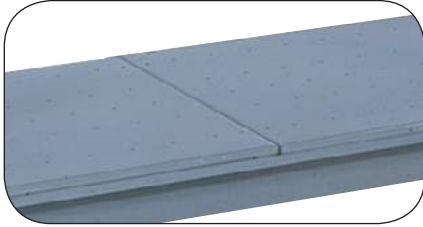

Solid Decking - Features Lyon heavy-duty industrial shelves for a smooth uninterrupted decking surface.



Particle Board Decking* - Durable, 5/8" thick particle board decking.

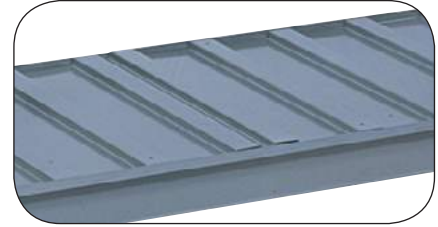

Ribbed Decking - Versatile 20-gauge ribbed decking. Ribs allow for space to grab packages easily and prevent pinched fingers. 1 3/4" w x 5/8" d rib.

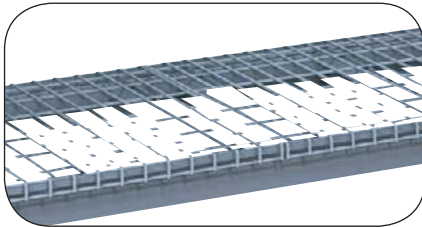

Wire Decking - This deck is the best choice when air circulation and light penetration are required. Also allows water to flow in the event a sprinkler system is activated. Available in Frost Gray (add prefix FF to the Cat. No.) Choose heavy-duty waterfall or light-duty flat wire decking:

Heavy-Duty Waterfall Decking - Featuring 4" x 2" wire mesh with heavy gauge welded channels for added strength and a 1 1/4" waterfall along both front and rear edge.

Light-Duty Flat Wire Decking - Featuring 4" x 2" wire mesh with 5-gauge welded reinforcement wires.

Beam Width Quantity of Decking Panels Required

48"	2 - 24" wide
60"	1 - 24" wide + 1 - 36" wide
72"	2 - 36" wide
84"	2 - 24" wide + 1 - 36" wide
96"	1 - 24" wide + 2 - 36" wide

Parts listed in single pack quantities, for multi-pack quantities, contact Customer Service at 1-800-323-0082

Width	Depth	Ribbed Decking		H. D. Wire Decking		Wire Decking		Solid Decking		Particle Board Decking	
		Cat. No.	Capacity	Cat. No.	Capacity	Cat. No.	Capacity	Cat. No.	Capacity	Cat. No.	Capacity
24"	24"	652241	1,400 lbs.	65454	1,200 lbs.	65454FW	550 lbs.	*	*	*	*
24"	30"	652301	1,200 lbs.	65456	1,200 lbs.	*	*	*	*	*	*
24"	36"	652361	1,000 lbs.	65458	1,700 lbs.	65458FW	550 lbs.	8562H	800 lbs.	72508	750 lbs.
24"	42"	652421	800 lbs.	65460	1,600 lbs.	*	*	8567X	880 lbs.	-	
24"	48"	652481	600 lbs.	65462	1,500 lbs.	65462FW	500 lbs.	8302X	750 lbs.	72528	750 lbs.
36"	24"	653241	1,800 lbs.	65472	1,700 lbs.	65472FW	550 lbs.	8562H	800 lbs.	72508	750 lbs.
36"	30"	653301	1,600 lbs.	65474	1,700 lbs.	*	*	8558H	740 lbs.	*	*
36"	36"	653361	1,400 lbs.	65476	1,700 lbs.	65476FW	550 lbs.	8586X	850 lbs.	*	*
36"	42"	653421	1,100 lbs.	65478	2,500 lbs.	*	*	8589X	820 lbs.	*	*
36"	48"	653481	900 lbs.	65480	1,500 lbs.	65480FW	500 lbs.	8592X	640 lbs.	72532	750 lbs.

Capacities are based on evenly distributed static load, with beams joined by correct number of front-to-back supports and no allowance for shock or uneven loading. Load is limited to support capacity of beams and upright assemblies.

*Items available through manufactured schedule.

Step 4

Select Front-to-Back Supports

One to four supports per level are required based on beam width and type of decking (see chart below).

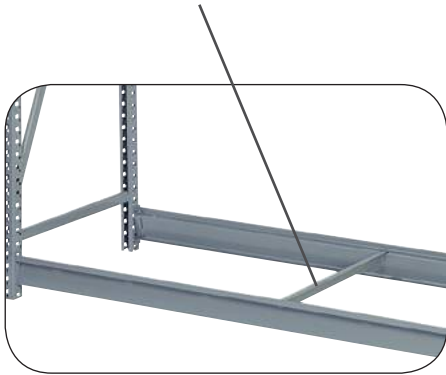

Used to minimize beam rotation under heavy loads. Also serves as a plywood support. No hardware or tools needed.

Rack Depth	Front-to-Back Supports Cat. No.
15"	65815
18"	65818
24"	65824
30"	65830
36"	65836
42"	65842
48"	65848

Minimum required when used with:

Beam Width	Plywood/ Particle Board	Solid/Ribbed/ Flat Wire/ No Deck
48"	2	1
60"	2	1
72"	3	2
84"	3	2
96"	4	2

Step 5

Select Accessories



Back-To-Back Support

Ties bulk storage rack back to back, maintains stability and spacing without interfering with storage space. Overall Extension: 12" - 17½"

No. 65140



Back-To-Wall Support

Bolts to upright member and wall to maintain shelving stability. Overall Extension: 12" - 17¼"

No. 65145



Anchoring Foot

To anchor upright assembly to floor. Dove Gray only.

No. 65130

Wedge Anchor

¾" dia x 3", 1 per post

No. 8861



End-Tie Plate

Ties Bulk Storage Rack back to back to maintain uniform spacing and stability. 3½" x 2½"

No. 65142



For Mezzanine Applications

Mezzanine Splice Channels

For two-level Bulk Storage Rack applications, simply insert reinforcing splice channels into bottom upright assembly posts and fit second-level upright assembly posts over channel extensions. The galvanized splice channels provide rigidity at the splice.

No. 65120

EASILY INTEGRATE BULK STORAGE RACKS

Bulk Storage Racks integrates seamlessly with 8000 Series shelving for a complete storage system.

8000 Series/BSR Integration Clip **No. 65160**



Additional Levels with Decking

Quickly add more levels to your Bulk Storage Rack shelving units with the decking options below. Unique “Z” Beam design increases strength and load capacity, resists tipping and eliminates wasted space. Beam clips are mig-welded for added strength. Fold in lock tab easily engages for security against displacement.

Available in Dove Gray.

Additional Levels Includes

Two (2) Heavy-duty, 14-gauge beams.
Front-to-back supports and/or decking panels to fit length of beam

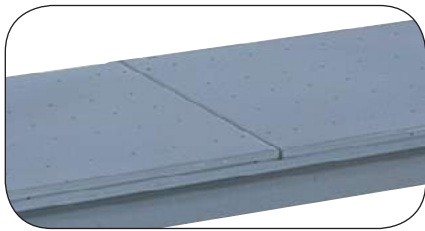

Solid Decking

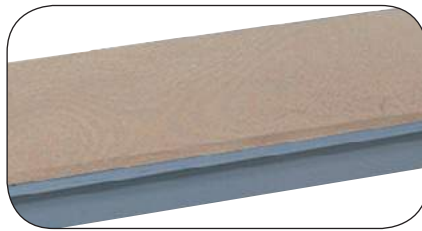

Particle Board Decking

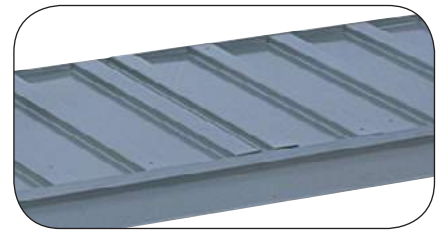

Ribbed Decking

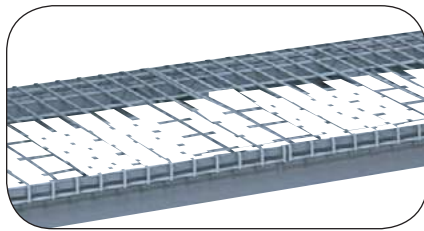

H.D. Decking

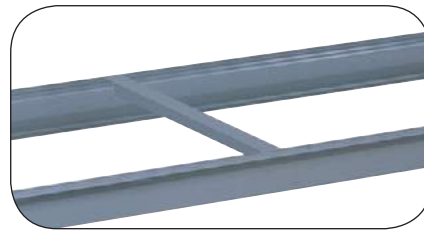

No Decking

Width	Depth	Height	No Decking		Particle Board Decking		Ribbed Decking		H.D. Decking		Solid Decking	
			Cat. No.	Capacity per Level	Cat. No.	Capacity per Level	Cat. No.	Capacity per Level	Cat. No.	Capacity per Level	Cat. No.	Capacity per Level
60"	24"	12"	DD66010	2,600 lbs	DD66010P	2,600 lbs	DD66010R	2,600 lbs	DD66030	2,600 lbs	-	-
	36"	12"	DD66011	2,600 lbs	DD66011P	2,600 lbs	DD66011R	2,600 lbs	DD66031	2,600 lbs	-	-
	48"	12"	DD66012	2,600 lbs	DD66012P	2,600 lbs	DD66012R	2,600 lbs	DD66032	2,600 lbs	-	-
72"	24"	12"	DD66013	1,900 lbs	DD66013P	1,900 lbs	DD66013R	1,900 lbs	DD66033	1,900 lbs	DD66023	1,900 lbs
	36"	12"	DD66014	1,900 lbs	DD66014P	1,900 lbs	DD66014R	1,900 lbs	DD66034	1,900 lbs	DD66024	1,900 lbs
	48"	12"	DD66015	1,900 lbs	DD66015P	1,900 lbs	DD66015R	1,900 lbs	DD66035	1,900 lbs	DD66025	1,900 lbs
96"	24"	12"	DD66016	1,650 lbs	DD66016P	1,650 lbs	DD66016R	1,650 lbs	DD66036	1,650 lbs	DD66026	1,650 lbs
	36"	12"	DD66017	1,650 lbs	DD66017P	1,650 lbs	DD66017R	1,650 lbs	DD66037	1,650 lbs	DD66027	1,650 lbs
	48"	12"	DD66018	1,650 lbs	DD66018P	1,650 lbs	DD66018R	1,650 lbs	DD66038	1,650 lbs	DD66028	1,650 lbs

NOTE: In the interest of safety, Lyon strongly recommends that racks that are 72" or higher be floor and/or wall anchored. See page 72 for important anchoring information.

Store up to 80 record storage boxes per unit with fast, easy access to every level. Assembly couldn't be easier, no tools required! Choose from three configurations.

Basic Rack

- Includes 14-gauge medium-duty beams
- Uprights, and center supports as required
(See page 70 for information)

Basic Rack with Support Rails

- Includes steel support rails

Basic Rack with Particle Board Decking

- Includes 5/8" thick particle board

Color Selection

- In Stock**
- DD** Dove Gray
- PP** Putty



Record storage boxes are sold separately.

Record Storage Starter and Add-on Sections

- **Starter uprights** are 14-gauge angle posts for use as stand alone sections or at the ends of rows of two or more sections
- **Add-on uprights** are 14-gauge T-posts for use as intermediate posts in multiple section rows



Record Storage Boxes

- Oyster white corrugated fiber boxes feature die-cut handle to provide sturdy storage for letter or legal size documents
- Space provided for labeling
- Shipped flat, 12 per carton
Overall: 12"w x 15"d x 10"h



No. 7390



Basic Rack



Basic Rack With Support Rails and Center Supports*



Basic Rack With Particle Board Decking

Record Storage Racks

W x D x H	No. of Levels	Capacity	Basic Rack		Basic Rack with Support Rails		Basic Rack with Particle Board	
			Starter Cat. No.	Add-On Cat. No.	Starter Cat. No.	Add-On Cat. No.	Starter Cat. No.	Add-On Cat. No.
69" x 16" x 60"	3	30 Boxes	73000	73000A	73000R	73000RA	73000P	73000PA
69" x 32" x 60"	3	60 Boxes	73002	73002A	73002R	73002RA	73002P	73002PA
69" x 16" x 84"	4	40 Boxes	73004	73004A	73004R	73004RA	73004P	73004PA
69" x 32" x 84"	4	80 Boxes	73006	73006A	73006R	73006RA	73006P	73006PA

*NOTE: Center support rails are recommended on racks over 60" wide. See page 70 for ordering information.

ACCESSORIES AND RELATED PRODUCTS

- Beams drop into slots on uprights to create a sturdy, rigid structure
- Starter uprights are 14-gauge angle posts for use as stand alone sections or at the ends of two or more sections
- Add-on uprights are 14-gauge T-posts for use as intermediate posts in multiple section rows
- Easy assembly

Color Selection

- In Stock**
- DD** Dove Gray
 - PP** Putty



Particle board and wire decking sold separately

Photo for illustrative purposes only

Pre-Engineered 84" High Rivet Rack

W x D x H	Capacity lbs.	3 Level		4 Level	
		Starter	Add-On	Starter	Add-On
Double-Rivet, Medium-Duty Flanged Beam					
48" x 24" x 84"	1,000	73020	73020A	73040	73040A
48" x 36" x 84"	1,000	73021	73021A	73041	73041A
48" x 48" x 84"	1,000	73022	73022A	73042	73042A
60" x 24" x 84"	800	73023	73023A	73043	73043A
60" x 36" x 84"	800	73024	73024A	73044	73044A
60" x 48" x 84"	800	73025	73025A	73045	73045A
72" x 24" x 84"*	800	73026	73026A	73046	73046A
72" x 36" x 84"*	800	73027	73027A	73047	73047A
72" x 48" x 84"*	800	73028	73028A	73048	73048A
96" x 24" x 84"*	650	73029	73029A	73049	73049A
96" x 36" x 84"*	650	73030	73030A	73050	73050A
96" x 48" x 84"*	650	73031	73031A	73051	73051A
"C" Channel, Heavy-Duty Beam					
96" x 24" x 84"*	1,200	73035	73035A	73055	73055A
96" x 36" x 84"*	1,200	73036	73036A	73056	73056A
96" x 48" x 84"*	1,200	73037	73037A	73057	73057A

* Includes Center support. Decking sold separately.

Particle Board Decking

Versatile particle board decking is 5/8" thick and pre-cut to size for use with Lyon rivet rack. For general purpose and record storage applications.

Actual Size	Cat. No.
36" x 12"	72504
36" x 18"	72506
36" x 24"	72508
48" x 12"	72524
48" x 18"	72526
48" x 24"	72528
48" x 36"	72532
48" x 48"	72534
60" x 24"	72544
60" x 36"	72546
60" x 48"	72548
72" x 24"	72554
72" x 36"	72556
72" x 48"	72558
96" x 24"	72564
96" x 36"	72566
96" x 48"	72568
69" x 16"	72580
69" x 32"	72582

Rivet Rack Wire Decking

Manufactured with 6-gauge wire 2" x 4" mesh. It meets fire code standards and features easy drop in installation, enhanced sprinkler system effectiveness and durable baked on enamel finish. Available in Frost Gray.

W x D	Capacity	Cat. No.
36" w x 12" d	350 lbs.	72604
36" w x 18" d	250 lbs.	72606
36" w x 24" d	250 lbs.	72608
48" w x 12" d	600 lbs.	72624
48" w x 18" d	600 lbs.	72626
48" w x 24" d	850 lbs.	72628
48" w x 36" d	800 lbs.	72632
48" w x 48" d	1,600 lbs.	72634
60" w x 24" d	800 lbs.	72644
60" w x 36" d	750 lbs.	72646
60" w x 48" d	500 lbs.	72648
72" w x 24" d	800 lbs.	72654
72" w x 36" d	750 lbs.	72656
72" w x 48" d	500 lbs.	72658
69" w x 16" d	850 lbs.	72680
69" w x 32" d	1550 lbs.	72682

Not recommended for single rivet beam applications.

Wall Tie

No. 72110 - Wall Tie 9"L, Fastens back to wall

Double Row Tie

No. 72115 - Double Row Tie 18"L, Ties double rows together

Hanging Bar for Clothes Hangers

No. 72120 - 36"L
No. 72121 - 42"L

Rivet Rack Tire

No. 72130 - Rivet Rack Tire Beam 60" (not shown)

Tie Plates

Lock posts together to join two or more racks side by side.
No. 72090 - 2 7/8" x 2 5/8"

Record Storage Box Support Rails

No. 72095 - 1 1/2" w x 16" d*
No. 72096 - 1 1/2" w x 32" d*
*Can only be used with 72052HR.

Center Supports

Overall: 1 1/2" w x 2 1/2" h. Use with beams 60" and wider.

- No. 72070** - 12"d
- No. 72071** - 15"d
- No. 72072** - 16"d
- No. 72073** - 18"d
- No. 72074** - 24"d
- No. 72075** - 30"d
- No. 72076** - 32"d
- No. 72077** - 36"d
- No. 72078** - 42"d
- No. 72079** - 48"d

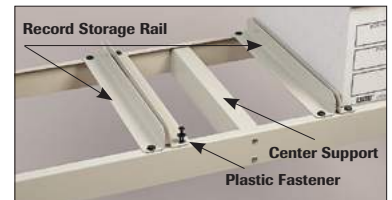
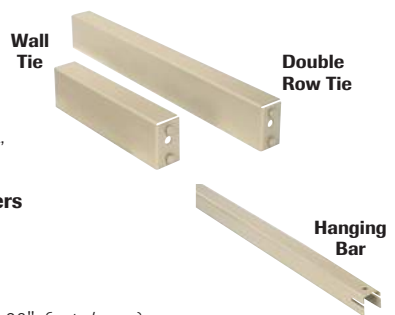

HOW TO ORDER **CUSTOM UNITS**

Each rack will require:

- 4 uprights
- 2 width beams per level
- 2 depth beams per level

Beams 60" and wider also require center supports.

All units utilizing single rivet beams require double rivet beams on both the top and bottom levels.

Available in these Colors

- DD** Dove Gray **PP** Putty

STEP 1

Determine the Height of Uprights Needed (qty 4)

Use angle posts for ends of rows and for stand-alone sections.

Use T-Post for intermediate uprights on multiple section rows.

STEP 2

Determine Width of Unit

Choose from:

- Single Rivet Light-Duty Beam
- Double Rivet Medium-Duty Beam
- "C" Channel Heavy-Duty Beam

STEP 3

Determine Depth of Unit

Choose from:

- Single Rivet
- Double Rivet

STEP 4

Select Center Supports

Required for beams 60" and wider.

STEP 5

Select Decking

Choose Particle Board or Wire Decking. See page 70

STEP 1

14-Gauge Steel Uprights

Height	Angle Post Cat. No.	T-Post Cat. No.
39"	72001K	N/A
60"	72003H	72017H
72"	72004H	72018H
84"	72005H	72019H
96"	72006H	72020H
120"	72007H	72021H
144"	72008H	72022H
168"	72009H	72080H
192"	72010H	72081H
216"	72011H	72082H
240"	72012H	72083H

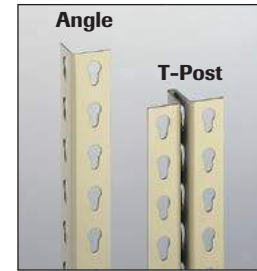

Angle posts:
1½" x 1½"

T-Posts:
3" x 1½"



STEP 2 & 3

14-Gauge Steel Beams

Single Rivet Light-Duty Beam

¾" w x 1" h

NOTE: Beam may be used for width or depth dimension, however, double rivet beams must be used at minimum at top and bottom locations for both depth and width directions for stability.

Double Rivet Medium-Duty Beam

¾" w x 2 5/8" h

NOTE: Beam may be used for width or depth dimension. Depth dimension not to exceed 48".

"C" Channel Heavy-Duty Beam

¾" w x 2 13/16" h

NOTE: Beam is recommended for width dimension only.

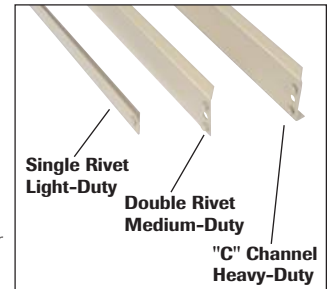

Beam Width	Single Rivet Light-Duty Beam		Double Rivet Medium-Duty Beam		"C" Channel Heavy-Duty Beam	
	Cat. No.	Cap.*	Cat. No.	Cap.*	Cat. No.	Cap.*
12"	N/A	N/A	72040H	N/A	N/A	N/A
15"	N/A	N/A	N/A	N/A	N/A	N/A
16"	N/A	N/A	72042H	N/A	N/A	N/A
18"	72028H	350	72043H	N/A	N/A	N/A
24"	72029H	350	72044H	N/A	N/A	N/A
30"	N/A	N/A	N/A	N/A	N/A	N/A
32"	N/A	350	72046H	800	N/A	N/A
36"	72031H	350	72047H	800	N/A	N/A
42"	N/A	N/A	N/A	N/A	N/A	N/A
48"	72033H	250	72049H	1,000	N/A	N/A
60"	N/A	N/A	72050H ⁽¹⁾	800	N/A	N/A
69"	N/A	N/A	72051H ⁽¹⁾	800	72061H ⁽¹⁾	1,400
72"	N/A	N/A	72053H ⁽²⁾	800	N/A	N/A
96"	N/A	N/A	72055H ⁽²⁾	650	N/A	N/A

Capacities based on dead weight evenly distributed over the entire surface per pair of beams. *Capacity in lbs. per shelf. ¹Requires one center support. ²Requires two center supports.

STEP 4

Center Supports

Overall: 1½" w x 2½" h. Use with beams 60" and wider.

- No. 72070 - 12"d
- No. 72071 - 15"d
- No. 72072 - 16"d
- No. 72073 - 18"d
- No. 72074 - 24"d

- No. 72075 - 30"d
- No. 72076 - 32"d
- No. 72077 - 36"d
- No. 72078 - 42"d
- No. 72079 - 48"d





Pallet Rack Starter and Add-On Units

To help take the hassle out of ordering Pallet Rack please select a starter or add-on unit.

Each unit is available as either 96" height or 144" height. 96" height units have two beam levels. 144" height units have three beam levels. Capacities vary based on beam width and largest beam spacing (see page 75). Units are available in 42" or 48" depth.

Level	Height	Depth	Width	Starter	Add-on	Deck Options	
2	96"	42"	96"	SFB096042096	AFB096042096	with F/B Supports	
			108"	SFB108042096	AFB108042096		
			120"	SFB120042096	AFB120042096		
			144"	SFB144042096	AFB144042096		
			96"	SWD096042096	AWD096042096		Wire Deck
			108"	SWD108042096	AWD108042096		
		120"	SWD120042096	AWD120042096			
		144"	SWD144042096	AWD144042096			
		48"	96"	SFB096048096	AFB096048096	with F/B Supports	
			108"	SFB108048096	AFB108048096		
			120"	SFB120048096	AFB120048096		
			144"	SFB144048096	AFB144048096		
			96"	SWD096048096	AWD096048096	Wire Deck	
			108"	SWD108048096	AWD108048096		
120"	SWD120048096		AWD120048096				
144"	SWD144048096		AWD144048096				
3	144"	42"	96"	SFB096042144	AFB096042144	with F/B Supports	
			108"	SFB108042144	AFB108042144		
			120"	SFB120042144	AFB120042144		
			144"	SFB144042144	AFB144042144		
			96"	SWD096042144	AWD096042144		Wire Deck
			108"	SWD108042144	AWD108042144		
		120"	SWD120042144	AWD120042144			
		144"	SWD144042144	AWD144042144			
		48"	96"	SFB096048144	AFB096048144	with F/B Supports	
			108"	SFB108048144	AFB108048144		
			120"	SFB120048144	AFB120048144		
			144"	SFB144048144	AFB144048144		
			96"	SWD096048144	AWD096048144	Wire Deck	
			108"	SWD108048144	AWD108048144		
120"	SWD120048144		AWD120048144				
144"	SWD144048144		AWD144048144				

Starters include two uprights, Add-ons include one upright.

Note: For "Big Foot Seismic" – Heavy-Duty Pallet Rack, please contact customer service at 1-800-323-0082

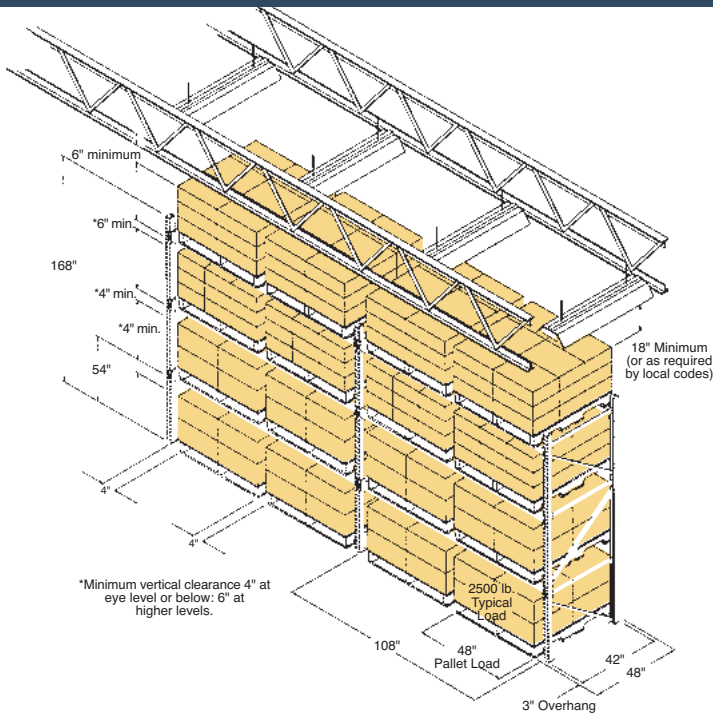

Note: For "Big Foot" – Heavy-Duty Pallet Rack, please contact customer service at 1-800-323-0082

PALLET RACK SAFETY RECOMMENDATIONS

Determine actual load requirements as accurately as possible and adhere to rated capacities shown in tables on the following pages. Additional precautions should be taken in applications where extraordinary rack abuse is anticipated. For example, when narrow aisles are used for high speed or high inventory turnover operations, Lyon recommends additional rack reinforcement. Impact supports and aisle guidance devices may be advisable – especially at aisle intersections and other vulnerable locations.

Beam Length

Lyon recommends a clearance of 4" between palletized loads – and between loads and uprights. Beams over 120" in length should be tied together with the appropriate front-to-back support to maintain proper spacing at each storage level.

Back-to-back Clearance

Clearance should be sufficient to accommodate minimum pallet overhang and tolerances – where pallet placement may vary. Additional clearances may be required to accommodate building structures or intermediate sprinkler systems (according to local codes).

Installation and Anchoring

To insure minimum stability standards, racks should be level, plumb and properly anchored.

Seismic Zones

Since requirements vary so widely, we advise you to contact Lyon for assistance on rack projects in high risk seismic zones.

Lyon's teardrop design features a roll form welded upright and is totally interchangeable with all major teardrop-style products on the market today.

Tough, durable, and smooth finish features our baked-on powder epoxy finish which gives an appliance-like finish that is impact and corrosion resistant.

Available in stock:

Lake Green – Upright Frames/Accessories
Safety Orange – Beams

Special Orders:

Additional capacities and dimensions are available upon request, contact Customer Service at 1-800-323-0082.

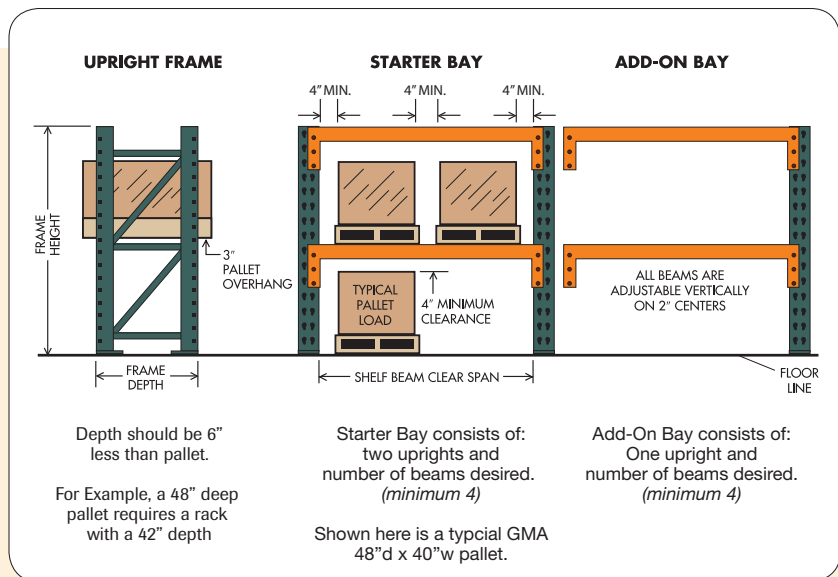

HOW TO ORDER PALLET RACKS

Step 1

Select Upright Frames (see page 74)

Add the following figures:

- Height of pallet loads (including pallet)
- + Height of shelf beam
- + 4" Min. vertical clearance for each pallet load

Sum of above dimensions = rack height

For uppermost load level, location of shelf beam should be 6" less than fork truck's maximum lift height. Top of beams need to be at even increments.

Step 2

Select Beams (see page 75)

Shelf length equals the distance between uprights. It is determined by adding the widths of pallet loads plus a 4" side clearance between upright and pallet and 4" between pallet loads.

Shelf beam capacities are based on a pair of beams supporting an evenly distributed load.

Beams over 120" in length should be tied together with the appropriate front-to-back support (see page 75) to maintain proper spacing at each storage level.

Step 3

Select Decking (see page 75)

Select Decking based on style needed:

- Solid Panel Decking
- Wire Decking

Step 4

Select Accessories (see page 76)



Upright Ordering Information

- Choose uprights to suit your storage requirements:
Medium-Duty - 3" x 2-1/4", 14 gauge
Heavy-Duty - 3" x 3", 13 gauge
- Two frames are required per bay, and any number may be joined together in continuous row applications
- Available in Lake Green



Uprights conform to the latest standards set by Rack Manufacturers' Institute LRFD Specifications.

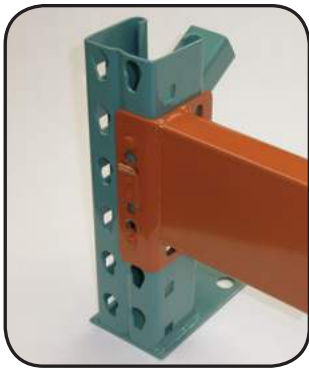

Unique Design - Roll formed upright provides greater strength-to-weight ratio. Minimum-sized slots mean more steel per upright. Upright's structures are 100% mig-welded with precision K-brace and heavy-duty cross channel reinforcement for increased strength, rigidity and resistance to abuse.

Easy Adjustment - Tapered keyhole slots on 2" centers, provide quick, easy vertical adjustment of beams. There are no "dead spots" or obstructions in upright posts to impede movement of beam along the entire height.

Interchangeable - Lyon pallet rack fits with other traditional teardrop designs. That means you can upgrade damaged, weak, or worn out uprights and beams with our versatile rack. No need to change your whole system.

Step 1

Select Upright Frames

1. Compute total frame capacity needed to satisfy your load requirements. *(Weight of heaviest pallet X number of pallets per level) X number of beam levels = total frame capacity*
2. Determine "Largest Beam Spacing". Vertical distance between floor and first beam level or vertical distance between beam spacing; whichever is greater.
3. Refer to the Upright Capacity Chart. Find the "Largest Beam Spacing" number that closest resembles the number determined in Step 2. Move down the table to the desired capacity required. This will identify if the upright is Medium or Heavy-Duty.
4. Using the required depth and height of the upright for the corresponding type identified in Step 3, select the appropriate catalog number from the table.

Largest Beam Spacing has a significant impact on the capacity rating of an upright.

Frame Height	Capacity per pair	36" Deep Cat. No.	42" Deep Cat. No.	48" Deep Cat. No.	Gauge
96"	20,600 lbs.	36M096	42M096	48M096	.075
120"	20,600 lbs.	36M120	42M120	48M120	.075
144"	20,600 lbs.	36M144	42M144	48M144	.075
192"	25,100 lbs.	-	42H192	48H192	.075
240"	29,800 lbs.	-	42H240	48H240	.085

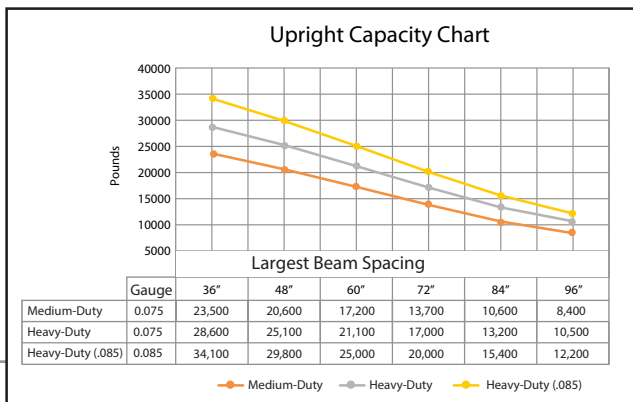

Beam Ordering Information

- Roll-formed beams feature an integrated 1/8" step for decking and are totally enclosed for clean applications
- Heavy-duty rivet-type connectors engage upright wedge slots for increased holding power
- Beams are easy to install, take down and relocate
- Available in Safety Orange



Three-Point Safety Catch – Each beam has 3 rugged studs (4 on heavy-duty) that engage the tapered keyhole slots in the upright with a compression fit. Integral safety lock automatically locks into place when beam is properly seated.

Step 2

Select Beams

1. Determine load weights per pair of beams.
(Two 2,500 lb. pallet loads = 5,000 lb. beam capacity).
2. Determine length of beam required based on load width and minimum clearances.
(Minimum clearance between pallet and upright is 4", or for two 48" pallets, a total of 12". Use 108" beam). (See illustration on page 73)
3. Refer to desired beam length and move across table to rated capacities.
(For 108" beam and 5,000 lb. load, select beam N108).

Clear Span	Capacity per pair	Beam-Face Height	Cat. No.
96"	5,200 lbs.	4.1"	N96
96"	8,330 lbs.	5"	S96
108"	6,320 lbs.	4.65"	N108
108"	9,940 lbs.	6"	S108
120"	6,140 lbs.	5"	N120
120"	8,920 lbs.	6"	S120
144"	6,790 lbs.	6"	N144
144"	9,370 lbs.	6.5"	S144

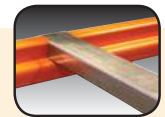

Beams 120" long and greater should be tied together with at least one front-to-back support except when solid decking panels are used.

Beams conform to the standards set by the latest Rack Manufacturers' Institute LRFID Specifications.

Step 3

Select Decking



Solid Decking Panels

Heavy, 14-gauge panels feature three 3" x 1 5/8" x 14-gauge hat channels welded to the underside for maximum strength and durability. Panels drop into place to provide a solid deck surface.

W x D	Capacity	Cat. No.
Solid Decking Panels		
48" x 30"	11,865 lbs.	DP4830
60" x 30"	11,865 lbs.	DP6030
48" x 36"	8,247 lbs.	DP4836
60" x 36"	8,247 lbs.	DP6036
48" x 42"	6,057 lbs.	DP4842
60" x 42"	6,057 lbs.	DP6042
48" x 48"	5,198 lbs.	DP4848
60" x 48"	5,198 lbs.	DP6048

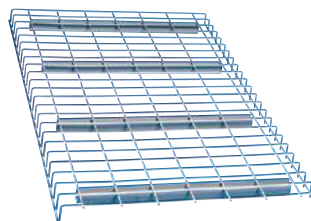

Wire Decking

Heavy-duty waterfall decking features a 2 1/2" x 4" 6-gauge wire mesh with 14-gauge steel channels for safe, durable storage and ease of installation. Meets all fire and safety regulations. Available in Frost Gray.

Wire decking sizes necessary to fit Lyon pallet rack

Beam Width	Wire Decking Sizes
90"	(2) 44"W
96"	(2) 46"W
102"	(1) 46"W and (1) 52"W
108"	(2) 52"W
120"	(2) 58"W
144"	(3) 46"W

W x D	# Channels	Capacity	Cat. No.
Wire Decking			
46" x 36"	3	2,750 lbs.	WD4636H
52" x 36"	3	2,500 lbs.	WD5236H
58" x 36"	3	2,500 lbs.	WD5836H
46" x 42"	4	3,500 lbs.	WD4642H
46" x 42"	3	2,000 lbs.	WD4642L
52" x 42"	4	3,500 lbs.	WD5242H
52" x 42"	3	2,500 lbs.	WD5242L
58" x 42"	3	3,000 lbs.	WD5842L
46" x 48"	4	3,000 lbs.	WD4648H
46" x 48"	3	2,500 lbs.	WD4648L
52" x 48"	3	2,800 lbs.	WD5248L
58" x 48"	3	3,000 lbs.	WD5848L



Step 4

Select Accessories

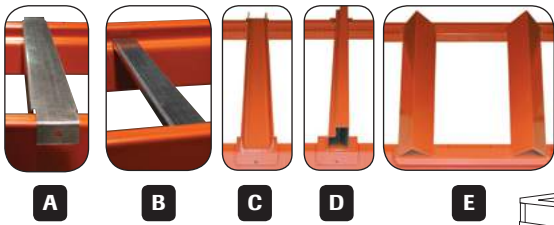

(A) Front-to-Back Support

Reduces the likelihood of inaccurately placed pallets falling through.

(B) Plywood Support Channel

To support plywood or other decking material, or as front-to-back member between beams.

(C) Skid Support

Provides secure, easily adjustable base for skid runners.

(D) Fork Entry Bar

Solid base and proper fork clearance for non-palletized loads.

(E) Drum Cradle

For safe storage of cylindrical items. Welded unit fits securely on beams.

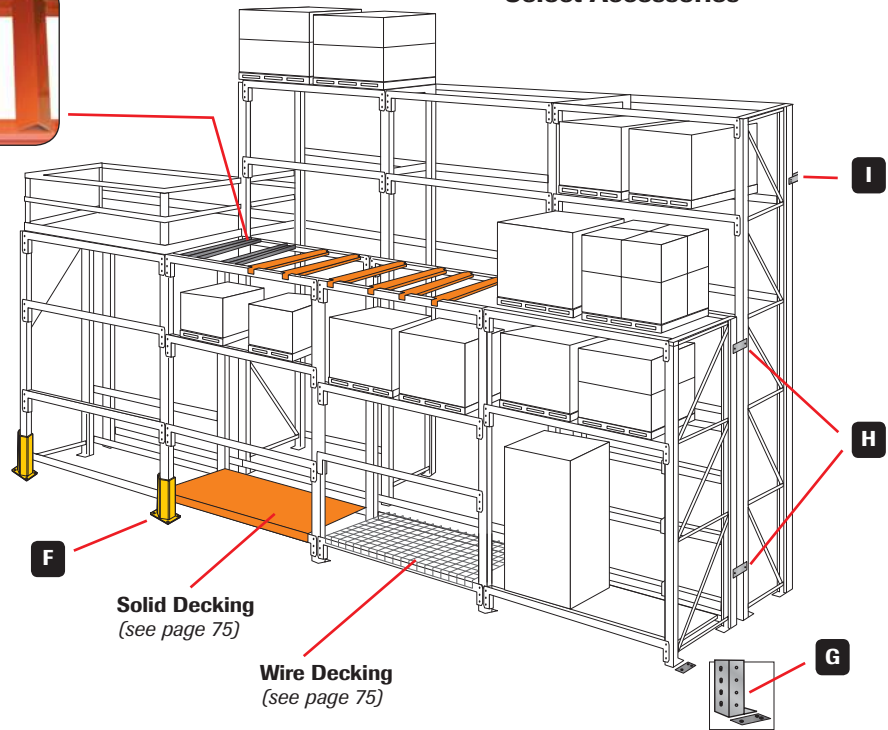

Solid Decking
(see page 75)

Wire Decking
(see page 75)

(F) Impact Support

Provides extra protection against abuse. Bolt on to floor only. Finish is Safety Yellow.

No. IMSUP12- 12" high
No. IMSUP24- 24" high
No. IMSUP36- 36" high
No. IMSUP48- 48" high



Upright Anchor

Optional wedge-type anchor can be used to secure column posts. 1/2" dia. x 3 3/4" long.

No. 25163



(G) Shim Plate

Nests under footplate. Unpainted.

No. FLSH34



(H), (I) Row Spacers & Wall Ties

Row spacer provides a stabilizing connection for back-to-back rows of racks; wall ties provide stability and consistent spacing from the wall. Galvanized construction resists rust and corrosion. Two spacers recommended for each pair of uprights. Bolts included.

Dimension	Capacity	Cat. No.
Front-to-Back Support		
36" Deep	1,840 lbs.	FBSUP36
42" Deep	1,540 lbs.	FBSUP42
48" Deep	1,320 lbs.	FBSUP48
Plywood Support Channel		
36" Deep	730 lbs.	PWSUP36
42" Deep	610 lbs.	PWSUP42
48" Deep	530 lbs.	PWSUP48
Skid Support		
36" Deep	650 lbs.	SKSUP36
42" Deep	550 lbs.	SKSUP42
48" Deep	475 lbs.	SKSUP48
Fork Entry Bar		
36" Deep	7000 lbs.	FEBAR36
42" Deep	6000 lbs.	FEBAR42
36" Deep	5000 lbs.	FEBAR48
Drum Cradle		
36" Deep	2170 lbs.	DRCD36
42" Deep	1860 lbs.	DRCD42

Dimension	Cat. No.
Row Spacer	
4"	RSPC04
6"	RSPC06
8"	RSPC08
10"	RSPC10
12"	RSPC12
18"	RSPC18
Wall Tie	
4"	WSPC04
6"	WSPC06
8"	WSPC08
10"	WSPC10
12"	WSPC12
18"	WSPC18

NOTE: Load-carrying capacities for individual accessories listed are based on evenly distributed loads and are limited by the support capacity of the beams and/or upright assemblies. When skid supports, fork-entry bars and/or front-to-back supports are used to support the load, the weight is not evenly distributed to the beam and, therefore, beam capacities are reduced significantly.

Store long items with maximum efficiency. Great for steel, iron, aluminum, wood, plastic tubes and other materials that are awkward to store on shelving or conventional racking.

All models feature heavy-duty arms with 450 lb. capacity that can be adjusted every 1½", with spacing as close as 7½".

Single-Face Rack:
3,000 lb. max capacity

Double-Face Rack:
6,000 lb. max capacity

Color Selection

- In Stock**
- DD** Dove Gray
- Also Available**
- PP** Putty
- BB** Wedgewood Blue

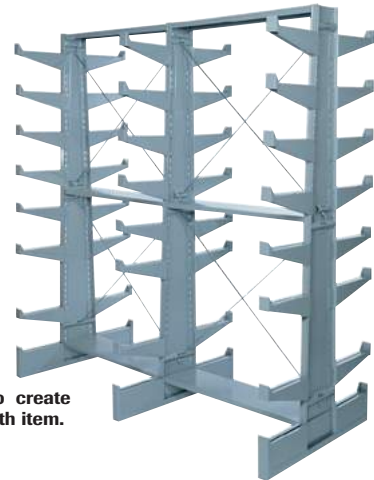

Join multiple racks to create storage for any length item.



Starter

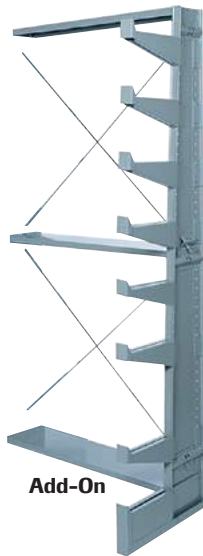

Add-On

Single-Face Rack

Designed for use against walls with arms and base on one side of uprights. Brace panels and cross braces included. Overall size: 36"w x 217⁄8"d x 79¼"h

No. 3700S – Starter
No. 3700 – Add-On
No. 3701 – Knocked Down Rack End
(converts Add-on into Starter)

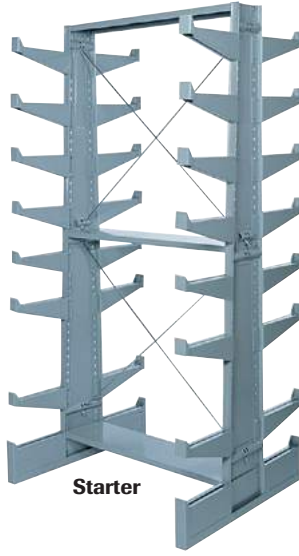

Starter



Add-On

Double-Face Rack

Designed for free-standing use with arms and base on both sides of uprights. Brace panels and cross braces included. Overall size: 36"w x 33¾"d x 79¼"h

No. 3710S – Starter
No. 3710 – Add-On
No. 3711 – Knocked Down Rack End
(converts Add-on into Starter)

ACCESSORIES AND RELATED PRODUCTS

Steel Shelves

Flanged back and notched corners fit all racks above. Makes Bar, Pipe and Rod Rack more versatile. 300 lb. capacity.
No. 3720 – 36"w x 12"d



Extra Arms and Separator Pegs

All arms are slotted for Separator Pegs *(order separately)*. Pegs are great for segmenting arms.
No. 3725 – Extra arm, 12" long
No. 3730 – Separator Peg, 4" high





Store bulky, irregular, long and odd-shaped items at low cost. Achieve maximum utilization of warehouse cube without front posts or columns to restrict horizontal space. Handle hard-to-store items, including appliances, building materials, fabrics, flooring, furniture, steel, pipe and other items, with ease. Wide, open rows allow proper load support and easy access.

- Units are 72" wide from center post to center post
- Choose single or double faced units in regular or heavy-duty strengths
- Arms are adjustable on 4" centers, and are available in 24", 36" and 48" lengths. Arm Slope = 4°
- Upright Frames, Brace Set Kits and accessories available in Green. Arms available in Safety Orange.

Single Face Racks

Per Arm Capacity	Upright Capacity	Starter Cat. No.	Add-On Cat. No.
Regular-Duty (8' High, 24" Arms)			
3,360 lbs.	17,548 lbs.	CSRSF09624S	CSRSF09624
Regular-Duty (10' High, 36" Arms)			
2,240 lbs.	13,800 lbs.	CSRSF12036S	CSRSF12036
Regular-Duty (12' High, 48" Arms)			
1,680 lbs.	11,371 lbs.	CSRSF14448S	CSRSF14448

Note: 8' high units are supplied with 4 arms, 10' and 12' high units are supplied with 5 arms per upright.

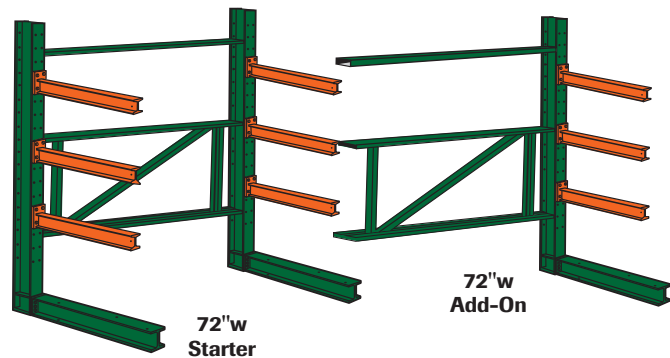

Double Face Racks

Per Arm Capacity	Upright Capacity	Starter Cat. No.	Add-On Cat. No.
Regular-Duty (8' High, 24" Arms)			
3,360 lbs.	17,548 lbs.	CSRDF09624S	CSRDF09624
Regular-Duty (10' High, 36" Arms)			
2,240 lbs.	13,800 lbs.	CSRDF12036S	CSRDF12036
Regular-Duty (12' High, 48" Arms)			
1,680 lbs.	11,371 lbs.	CSRDF14448S	CSRDF14448

Note: 8' high units are supplied with 4 arms, 10' and 12' high units are supplied with 5 arms per upright. Upright capacities are per side. Double stated capacity is for Double Face Racks.

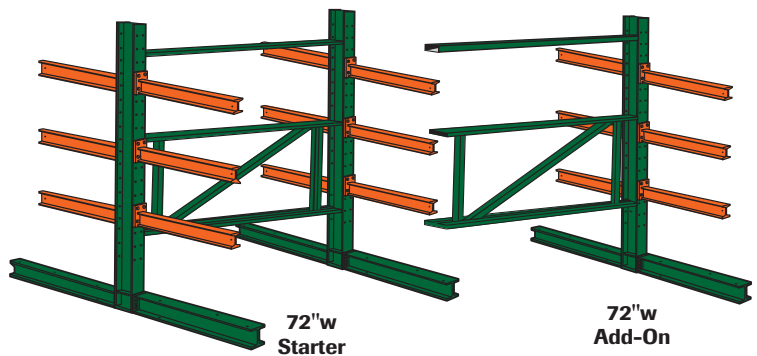

Part Number	Height	Description	Duty	Capacity	Color
Columns					
LSC0818C096	96"	Column - 11371#	Regular	11371	Green Sr-121
LSC0818C120	120"	Column - 11371#	Regular	11371	Green Sr-121
LSC0818C144	144"	Column - 11371#	Regular	11371	Green Sr-121
Wedge Anchor					
LSHRAWL7433	N/A	5/8" x 5"	Regular	N/A	Plain
Regular Duty Arms					
LSC357A024	3"	24" - 3360#	Regular	3360	Orange Sr-132
LSC357A036	3"	36" - 2240#	Regular	2240	Orange Sr-132
LSC357A048	3"	48" - 1680#	Regular	1680	Orange Sr-132
Heavy Duty Arms					
LSC477A036	4"	36" - 4053#	Heavy	4053	Orange Sr-132
LSC477A048	4"	48" - 3040#	Heavy	3040	Orange Sr-132
Part Number	Length	Description	Duty	Capacity	Color
Brace Panels					
LSCCBPW048	48"	Brace Panel	Regular	N/A	Green Sr-121
LSCCBPW060	60"	Brace Panel	Regular	N/A	Green Sr-121
LSCCBPW072	72"	Brace Panel	Regular	N/A	Green Sr-121
Horizontal Braces					
LSCCHBW048	48"	Horizontal Brace	Regular	N/A	Green Sr-121
LSCCHBW060	60"	Horizontal Brace	Regular	N/A	Green Sr-121
LSCCHBW072	72"	Horizontal Brace	Regular	N/A	Green Sr-121
Part Number	Depth	Description	Duty	Capacity	Color
Bases					
LSC0818B024	24"	Base	Regular	N/A	Green Sr-121
LSC0818B036	36"	Base	Regular	N/A	Green Sr-121
LSC0818B048	48"	Base	Regular	N/A	Green Sr-121

*Based on 48" Arms. Shorter Arms are higher capacity.

*Structural cantilever is made from wide flange steel for columns, bases and arms and all are fastened through a high strength connection.

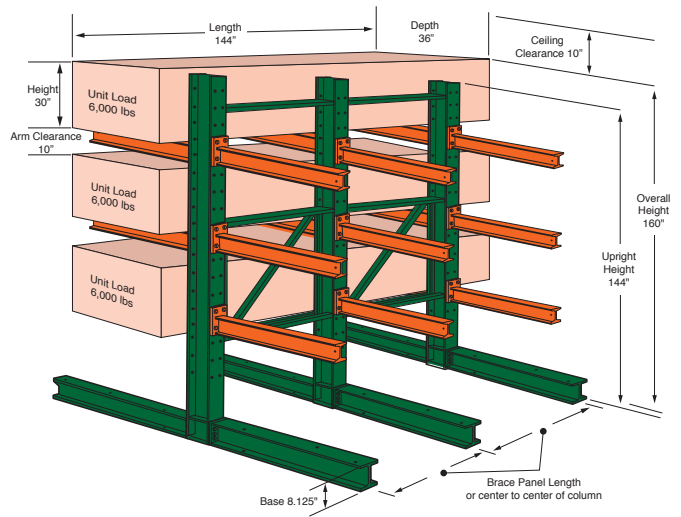

*NOTE: Base load not included to determine upright capacity.

End view of Regular and Heavy-Duty uprights.

Nominal Depth	A	B	Single Sided C	Double Sided D
Regular				
24"	24"	8.125"	32.125"	56.125"
36"	36"	8.125"	44.125"	80.125"
48"	48"	8.125"	56.125"	104.125"
Heavy-Duty				
24"	24"	8.125"	32.125"	56.125"
36"	36"	8.125"	44.125"	80.125"
48"	48"	8.125"	56.125"	104.125"

Brace Set Kits

Brace Kits determine the width of the unit. Tie upright assemblies together for added strength. 96" and 120" tall units require one brace panel. 144" tall units require one brace panel and a horizontal brace. Taller units will require additional bracing and (or) panels.

Upright Frames, Brace Set Kits and accessories available in Green. Arms available in Safety Orange.

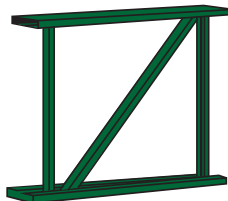

Brace Panel Assembly



How to Order - Rack Arm

Divide the total weight by the number of arms required. Example: with a load weight of 6,000 lbs. on 3 arms, each arm needs a capacity of at least 2,000 lbs. (6,000 divided by 3).

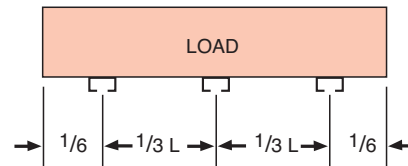
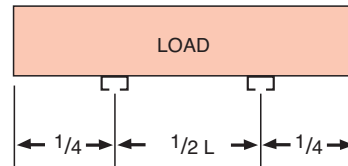
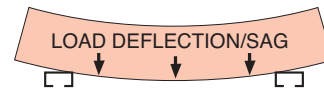
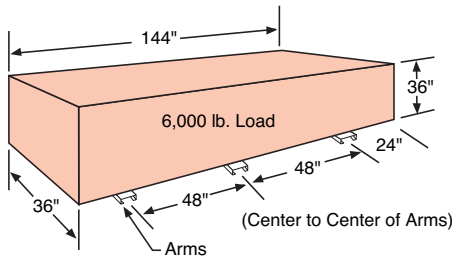

Stacking Height and Vertical Arm Spacing

1. Height to ceiling: Measure distance from floor to ceiling and subtract 10" clearance (subtract 18" clearance where ceiling sprinklers are present). Consult building codes in your area for exact clearance required.
2. Allow for equipment capabilities: When usable floor-to-ceiling space exceeds equipment lift heights, determine maximum equipment lift height and subtract 6" margin. Add the height of top level load for revised stacking height.
3. Number of load levels: For loads of consistent size, determine height of one load plus 10" for arm clearance. Divide that stacking height by dimension above to determine number of possible load levels.

Horizontal Arm Spacing

When figuring the length of a load, allow for clearance between loads; 8 to 10 inches is a good rule of thumb for long loads. Check rack arm spacing with fork arm spacing on handling equipment for safe working clearances.

1. Arm spacing is determined by degree of load deflection between arms, which is dependent on rigidity of load. For safe loads with two-arm support, distance between arms should be 1/2 the load length. Three-arm support should be 1/3 the load length.
2. You can perform on-site tests by setting required load on two 2x4's on floor at maximum arm spacing (96") and reduce spacing in 24" increments to arrive at an acceptable sag tolerance. If necessary, add more 2x4's to accomplish this. Loose loads have a tendency to sag more than bundled loads.

Slotted Angle

With Lyon Slotted Angle, you can build an infinite number of custom structures!

Solve unique storage problems with the convenience and strength of Lyon slotted angle. It's easy to build what you need – when and where you need it:

- Non-standard sizes of storage racks
- Protective framing around machinery
- Platforms around assembly projects
- Support framing for displays
- Unique configurations in hospitals, museums, retail outlets, lumberyards, schools – the list is virtually endless
- Made from rugged, cold-rolled steel with heavy, non-flaking galvanized finish. All are clearly stamped on 3" centers for quick, simple measuring and cutting
- Oval horizontal and vertical holes allow precise adjustment of angles

Available in all steel components, Galvanized Silver

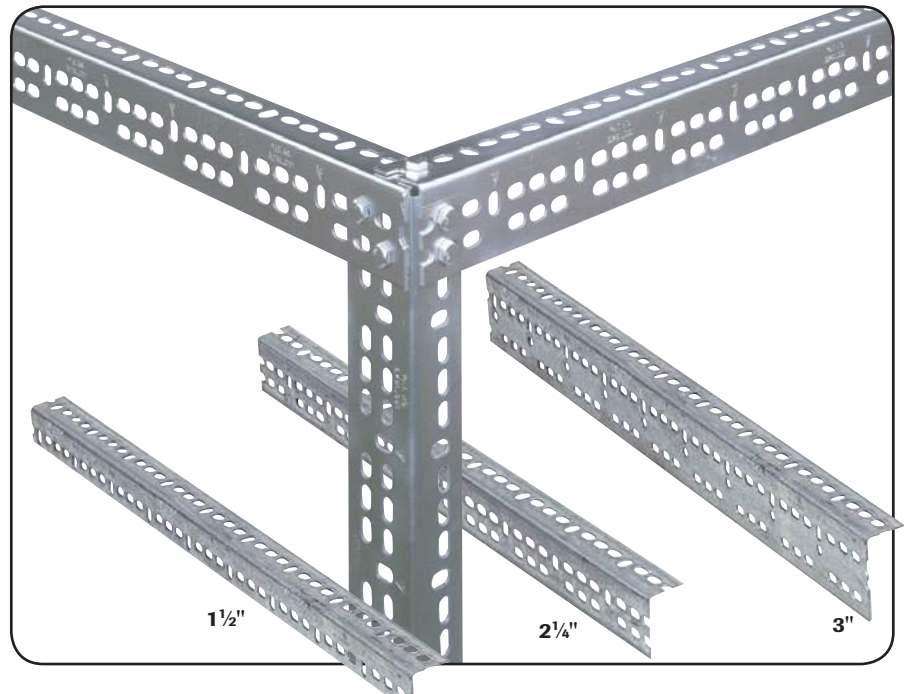

ACCESSORIES AND RELATED PRODUCTS

Gussets

Bolt to upright and cross member to assure complete rigidity. 14-gauge cold-rolled steel with heavy-galvanized finish.



No. 6572 – 6" x 6" Gusset - 12 pack

Casters

Hard composition wheels are 3 1/2" in diameter with 15/16" tread. Slotted holes in steel plate for use on both size angles.



No. 6586 – Stationary Caster - 2 pack

No. 6587 – Ball-Bearing Swivel Caster - 2 pack

Extra Nuts and Bolts

Hex head self locking 5/16" diameter nuts and 3/4" long bolts.

No. 6578 - 100 pack



W x D x H	Qty. Per Package	Cat. No.
14-Gauge Light-Duty		
1 1/2" x 1 1/2" x 10'	10	6530
1 1/2" x 1 1/2" x 10'	120 in 12 pkgs	6530-12
1 1/2" x 1 1/2" x 12'	10	6532
1 1/2" x 1 1/2" x 12'	120 in 12 pkgs	6532-12
14-Gauge Medium Duty		
2 1/4" x 1 1/2" x 8'	10	6508
2 1/4" x 1 1/2" x 8'	120 in 12 pkgs	6508-12
2 1/4" x 1 1/2" x 10'	10	6510
2 1/4" x 1 1/2" x 10'	120 in 12 pkgs	6510-12
2 1/4" x 1 1/2" x 12'	10	6512
2 1/4" x 1 1/2" x 12'	120 in 12 pkgs	6512-12
12-Gauge Heavy-Duty		
3" x 1 1/2" x 10'	10	6520
3" x 1 1/2" x 10'	120 in 12 pkgs	6520-12
3" x 1 1/2" x 12'	10	6522
3" x 1 1/2" x 12'	120 in 12 pkgs	6522-12



Choose From 1 1/2", 2 1/4" and 3" For Light, Medium and Heavy-Duty Applications

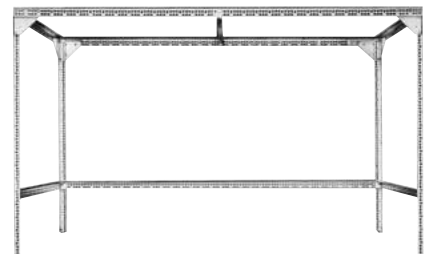

Colors help employees quickly identify the type of chemicals being stored. While it is not mandated to use specific colors for safety cabinets, Lyon follows industry standard for color coding in their safety storage cabinet design. Color coding can also help first responders in the event of an emergency situation.

- Yellow for Flammable Liquids
(add prefix 74 to Cat. No.)
- Blue for Acid and Corrosives
(add prefix 23 to Cat. No.)
- Green for Pesticide
(add prefix 30 to Cat. No.)
- Red for Paints and Inks
(add prefix HH to Cat. No.)



Flammable Liquids



R5471
12-Gallon
43" x 18" x 18"



R5472/R5465
17-Gallon
43" x 18" x 24"



R5473
12-Gallon
23³/₄" x 18" x 35"



R5474
15-Gallon
23³/₄" x 18" x 44"



R5466/R5469
20-Gallon
43" x 12" x 44"



R5467
22-Gallon
35" x 22" x 35"



R5440N
30-Gallon
43" x 18" x 44"



R5441N - Self-Closing Door
30-Gallon
43" x 18" x 44"



R5444N
45-Gallon
43" x 18" x 65"



R5445N - Self-Closing Door
45-Gallon
43" x 18" x 65"



R5460
60-Gallon
32" x 32" x 65"

Paint and Inks



R5640
30-Gallon
43" x 18" x 44"



R5641
30-Gallon
43" x 18" x 44"



R5660
45-Gallon
43" x 18" x 65"



R5661
45-Gallon
43" x 18" x 65"

Acid and Corrosives



R5595
22-Gallon
35" x 22" x 35"



R5566/R5569
20-Gallon
43" x 12" x 44"



R5540
30-Gallon
43" x 18" x 44"



R5541
30-Gallon
Self-Closing Door
43" x 18" x 44"



R5544
45-Gallon
43" x 18" x 65"



R5545
45-Gallon
Self-Closing Door
43" x 18" x 65"

Pesticide Storage



R5773
12-Gallon
23³/₄" x 18" x 35"



R5740
30-Gallon
43" x 18" x 44"



R5741
30-Gallon
Self-Closing Door
43" x 18" x 44"



R5744
45-Gallon
43" x 18" x 65"



R5745
45-Gallon
Self-Closing Door
43" x 18" x 65"

Choosing the Right Cabinet:

Flammable Liquid • Acids and Corrosives • Paints and Inks • Pesticides



Step 1

Identify the type of chemicals to be stored and choose from the cabinets listed above.

Step 2

Identify the size of containers being stored and your capacity requirements.

Step 3

Choose the Door Style that best fits your needs. (Some states or locales follow either the *International Fire Code* or *NFPA 1 Uniform Fire Code™* which mandates the use of self-closing cabinets.)

Manual and Self-Closing Doors



Manual-closing door



Self-closing doors feature manual latch with fusible link.

Latch holds door open when in use and will release to close door automatically when temperatures reach 165°F.

Full length continuous door hinges

Powder coat finish



Heavy-duty ribbed, galvanized steel shelves deliver load capacity of 350 lbs. per shelf and are adjustable on 3" vertical centers

Screened flame arrester vents on both sides of cabinet (one high and one low) are threaded to accept standard 2" pipe for external exhaust

Four, Zinc-plated leveling legs included

All-welded 18-gauge, double wall construction with 1½" of insulating air space offers fire resistant protection



Black, flush-mounted paddle handle design allows easy fingertip operation and features a double key set and can be padlocked (padlock not included)

Slam-action closing mechanism utilizes a three-point stainless steel bullet latching system.

Ground wire connection deters static build-up (wire not included)

2" high leak-proof bottom pan

Polyethylene Shelf Liners



Replaceable, leakproof 2" deep trays offer additional protection with a slightly raised curved edge to contain spills. Shelf liners are included with Acids and Corrosives, and Pesticides Cabinets. Optional with Flammable Liquids, and Paints and Inks Cabinets.

- Conforms to NFPA Fire Code No. 30 and OSHA standards
- Adjust or add shelves to accommodate different size, or additional containers
- Optional polyethylene trays offer additional protection
- For specifications and features, see page 83



 Yellow for Flammable Liquids (add prefix 74 to Cat. No.)

Capacity	W x D x H	No. of Shelves	Cat. No. Manual-Closing	Cat. No. Self-Closing	Cabinet Options		
					Cat. No. Extra Shelf	Cat. No. Mounting Brackets	Cat. No. Tray
Standard							
30 gal.	43" x 18" x 44"	1	R5440N	R5441N	N5449	N/A	5550
45 gal.	43" x 18" x 65"	2	R5444N	R5445N	N5449	N/A	5550
60 gal.	32" x 32" x 65"	2	R5460	R5461	N5450	N/A	N/A
Compact							
4 gal.	17" x 17" x 22"	1	R5470	N/A	N5478	5480	N/A
12 gal.	23-1/4" x 18" x 35"	1	R5473	N/A	N5476	N/A	N/A
12 gal.	43" x 18" x 18"	—	R5471	N/A	N/A	5479	N/A
15 gal.	23-1/4" x 18" x 44"	1	R5474	N/A	N5476	N/A	N/A
17 gal.	43" x 18" x 24"	1	R5472	N/A	N5449	5479	N/A
17 gal.	43" x 18" x 24"	1	R5465*	N/A	N5449	included	N/A
20 gal.	43" x 12" x 44"	2	R5466*	N/A	N5477	included	N/A
20 gal.	43" x 12" x 44"	2	R5469	N/A	N5477	5479	5552
Under-Counter							
22 gal.	35" x 22" x 35"	1	R5467	N/A	N5468	N/A	5568

Note: Not Recommended for Phenol, Sulfuric or Nitric Acids.

*Includes brackets for wall-mounting.

- Conforms to NFPA Fire Code No. 30 and OSHA standards
- Adjust or add shelves to accommodate different size, or additional containers
- To resist aggressive chemicals, these cabinets also **include** polyethylene trays for the shelves and the bottom pan
- For specifications and features, see page 83



■ Blue for Acid and Corrosives (add prefix 23 to Cat. No.)

Capacity	W x D x H	No. of Shelves	No. of Trays	Cat. No. Manual-Closing	Cat. No. Self-Closing	Cabinet Options		
						Cat. No. Extra Shelf	Cat. No. Replacement Tray	Cat. No. Mounting Brackets
Standard								
30 gal.	43" x 18" x 44"	1	2	R5540	R5541	N5449	5550	N/A
45 gal.	43" x 18" x 65"	2	3	R5544	R5545	N5449	5550	N/A
Compact								
12 gal.	43" x 18" x 18"	-	1	R5591	N/A	N5449	5550	5479
17 gal.	43" x 18" x 24"	1	2	R5592	N/A	N5449	5550	5479
17 gal.	43" x 18" x 24"	1	2	R5565*	N/A	N5449	5550	included
20 gal.	43" x 12" x 44"	5	6	R5566*	N/A	N5477	5552	included
20 gal.	43" x 12" x 44"	5	6	R5569	N/A	N5477	5552	5479
Under-Counter								
22 gal.	35" x 22" x 35"	1	2	R5595	N/A	N5468	5568	N/A

Note: Not Recommended for Phenol, Sulfuric or Nitric Acids.

*Includes brackets for wall-mounting.

Adjustable shelves offer the ideal solution for storing the wide variety of containers for paints and inks – from half pints to 5 gallon pails – all in one cabinet

- Conforms to NFPA Fire Code No. 30 and OSHA standards
- Separate and identify Class III combustibles
- Adjust or add shelves to accommodate different size, or additional containers
- Optional polyethylene trays offer additional protection
- For specifications and features, see page 83



■ Red for Paints and Inks (add prefix HH to Cat. No.)

Capacity	W x D x H	No. of Shelves	Cat. No. Manual-Closing	Cat. No. Self-Closing	Cabinet Options	
					Cat. No. Extra Shelf	Cat. No. Replacement Tray
Standard						
30 gal.	43" x 18" x 44"	3	R5640	R5641	N5449	5550
45 gal.	43" x 18" x 65"	5	R5660	R5661	N5449	5550

Adjustable shelves offer the ideal solution for storing various containers of companies who specialize in lawn care, golf course management, agricultural interest or just handle pesticides.

- Conforms to NFPA Fire Code No. 30 and OSHA standards
- Adjust or add shelves to accommodate different size, or additional containers
- To resist aggressive chemicals, these cabinets also **include** polyethylene trays for the shelves and the bottom pan
- For specifications and features, see page 83



■ Green for Pesticide (add prefix 30 to Cat. No.)

Capacity	W x D x H	No. of Shelves	No. of Trays	Cat. No. Manual-Closing	Cat. No. Self-Closing	Cabinet Options		
						Cat. No. Extra Shelf	Cat. No. Mounting Brackets	Cat. No. Replacement Tray
Standard								
30 gal.	43" x 18" x 44"	1	2	R5740	R5741	N5449	N/A	5550
45 gal.	43" x 18" x 65"	2	2	R5744	R5745	N5449	N/A	5550
Compact								
12 gal.	23-1/4" x 18" x 35"	1	2	R5773	N/A	N5476	5479	5548

HazMat Response Cabinets

Organize and store your spill containment/ HazMat response equipment on the shop floor, close to the areas at greatest risk. Safety experts agree that rapid response to a HazMat emergency can greatly reduce risk exposure and collateral damage

- Shelves adjustable on 2" centers
- Double doors swing full 180° for maximum access
- 3-point locking device
- Shipped fully assembled, ready to use
- Safety yellow finish
- Overall size: 36"w x 24"d x 78"h

No. 5460HM – Cabinet with 4 shelves

No. 5461HM – Cabinet with center partition, coat rod, full width shelf and 4 half shelves (*permits storage of HazMat response apparel on hangers*)



5460HM



5461HM



Safety Centers allow you to quickly evaluate supply inventory without even opening the doors.

- Includes four full-width shelves
- Ships set up
- Yellow finish only
- Overall Size: 48"w x 24"d x 82"h

No. 1120SC

Extra 48"w Shelf for 1120SC

No. 1161



Lyon has long been America's leading manufacturer of a complete line of quality lockers and accessories for schools, hospitals, and industry. Lyon lockers include:

- Recessed handle standard
- Secure latching system increases the break-in protection compared to existing locker latching systems
- Nylon lockbar glides quiet door operations
- All door frame corners are lapped and welded to form a strong, rigid assembly
- All one-piece locker door construction from prime, high-grade Class 1 16-gauge steel for extra strength and durability
- One piece, top-to-bottom 16-gauge steel door-strike on all lockers for strength and security
- Single-Tier Lockers includes a separate shelf space for books, electronics, lunches, etc.
- 6" Louvers



Color Selection

In Stock

- DD Dove Gray
- PP Putty



Additional colors are available upon request

Alternate color selections only include the door and frame assembly. Interior components including; tops, bottoms, sides, backs, and shelves will be painted putty.

Dove Gray and Putty Lockers from stock will include matching interior components.



ADA REQUIREMENTS FOR LOCKERS



1. Doors must be able to be opened without a twisting or clasping motion. The standard test for compliance is if the door can be opened with closed fingers.

A recessed handle with a lockbar or single point is compliant.

2. The locker bottom must be a minimum of 15" from the finished floor. This is accomplished by locating a shelf 12" from the bottom of the locker. Additional shelves can be purchased separately, contact Lyon Customer Service. The shelf is acceptable as the locker bottom and when the locker is placed on a minimum 3" base the shelf/bottom is a minimum of 15" from the finished floor.

3. The locker shelf or hooks can not exceed 48" from the finished floor. The shelf and hooks can be relocated during set-up.

Contact Lyon Customer Service for more ADA product specs, and project support on choosing the best locker solution for your project.

NOTE: In the interest of safety, Lyon strongly recommends that lockers be floor and/or wall anchored. See page 92 for important locker anchoring information.

W x D x H* (per locker opening)	No. of Frames	No. of Openings	K.D. Cat. No.	Set Up Cat. No.
Single Tier				
12" x 12" x 60"	1	1	5002	5002SU**
12" x 12" x 60"	3	3	50023	50023SU**
12" x 15" x 60"	1	1	5012	5012SU**
12" x 15" x 60"	3	3	50123	50123SU**
12" x 18" x 60"	1	1	5022	5022SU**
12" x 18" x 60"	3	3	50223	50223SU**
12" x 12" x 72"	1	1	5112	5112SU**
12" x 12" x 72"	3	3	51123	51123SU**
12" x 15" x 72"	1	1	5032	5032SU**
12" x 15" x 72"	3	3	50323	50323SU**
12" x 18" x 72"	1	1	5042	5042SU
12" x 18" x 72"	3	3	50423	50423SU
15" x 18" x 72"	1	1	5062	5062SU**
15" x 18" x 72"	3	3	50623	50623SU**
18" x 18" x 72"	1	1	5092	5092SU**
18" x 18" x 72"	3	3	50923	50923SU**
18" x 21" x 72"	1	1	5102	5102SU**
18" x 21" x 72"	3	3	51023	51023SU**
Double Tier				
12" x 12" x 30"	1	2	5242	5242SU**
12" x 12" x 30"	3	6	52423	52423SU**
12" x 12" x 36"	1	2	5202	5202SU**
12" x 12" x 36"	3	6	52023	52023SU**
12" x 15" x 36"	1	2	5212	5212SU**
12" x 15" x 36"	3	6	52123	52123SU**
12" x 18" x 36"	1	2	5222	5222SU
12" x 18" x 36"	3	6	52223	52223SU
15" x 15" x 36"	1	2	5252	5252SU**
15" x 15" x 36"	3	6	52523	52523SU**
Triple Tier				
12" x 15" x 24"	1	3	5283	5283SU**
12" x 15" x 24"	3	9	52833	52833SU**

*Heights shown do not include legs – add 6" to height for legs.

**Call Customer Service for lead time.

Provide high density storage for individual belongings and supplies. Great in classrooms, laboratories, gymnasiums, sports and recreational facilities, and more.

- Pull Handles with built-in padlock loop are standard on multiple tier lockers. Optional roll point catch available.
- Doors with built-in locks have no pulls
- Door frame corners are overlapped and welded for strength
- 6" legs — rear legs are adjustable for leveling
- 3" louvers for ventilation



Color Selection

In Stock

- DD** Dove Gray
- PP** Putty



Additional colors are available upon request

Alternate color selections only include the door and frame assembly. Interior components including; tops, bottoms, sides, backs, and shelves will be painted putty.

Dove Gray and Putty Lockers from stock will include matching interior components.

Example

Order one **No. 5332** & receive this one section: **one frame wide (six locker openings).**

Order one **No. 53323** & receive this one section: **three frames wide (eighteen locker openings).**



"Set Up" means product ships fully assembled.
"K.D." means knocked down, ships flat and assembly is needed.



NOTE: In the interest of safety, Lyon strongly recommends that lockers be floor and/or wall anchored. See page 92 for important locker anchoring information.

W x D x H* (per locker opening)	No. of Frames	No. of Openings	K.D. Cat. No.	Set Up Cat. No.
Four Tier				
12" x 12" x 12"	1	4	5352	5352SU**
12" x 12" x 12"	3	12	53523	53523SU**
Five Tier				
12" x 12" x 12"	1	5	5302	5302SU**
12" x 12" x 12"	3	15	53023	53023SU**
12" x 15" x 12"	1	5	5312	5312SU**
12" x 15" x 12"	3	15	53123	53123SU**
15" x 15" x 12"	1	5	5322	5322SU**
15" x 15" x 12"	3	15	53223	53223SU**
Six Tier				
12" x 12" x 12"	1	6	5332	5332SU**
12" x 12" x 12"	3	18	53323	53323SU**
12" x 15" x 12"	1	6	5342	5342SU**
12" x 15" x 12"	3	18	53423	53423SU**
12" x 18" x 12"	1	6	5362	5362SU**
12" x 18" x 12"	3	18	53623	53623SU**

*Heights shown do not include legs — add 6" to height for legs.

**Call Customer Service for lead time.

ACCESSORIES AND RELATED PRODUCTS

See pages 92-93



Two Person Lockers

Ample storage for two people in a space only 15" wide!

- Each occupant has a full-length coat compartment with two hooks, plus a full-width opening at top for small articles
- Left door and upper compartment work together as do the right-hand door and lower compartment
- Coat compartment doors have recessed handles with padlock attachments
- Built-in locks are optional
- Available shipped K.D. (knock down) or Set-up
- Locker opening dimensions:
Small – 15" w x 18" d x 9" h,
Large – 7½" w x 18" d x 54" h

Features



Small upper door is released with a latch inside the corresponding coat compartment door.

Ideal for the Healthcare Industry!

Add optional antimicrobial finish for protection against the touch transfer of bacteria on locker surfaces.

See page 91 for details on how antimicrobial protection works.



Example

Order one **No. 5407** & receive this one section: **one frame wide (four locker openings for two people).**

Order one **No. 54073** & receive this one section: **three frames wide (twelve locker openings for six people).**



Color Selection

In Stock

- DD** Dove Gray
- PP** Putty



Additional colors are available upon request

Alternate color selections only include the door and frame assembly. Interior components including; tops, bottoms, sides, backs, and shelves will be painted putty.

Dove Gray and Putty Lockers from stock will include matching interior components.

Lockerack®

- Provides coat storage and lock-up compartments for 16 people in approximately one square foot per person
- Door pulls serve as padlock hasps (padlocks not furnished)
- Built-in locks and number plates may be added (see page 92)
- Shipped set up, or knocked down with frames and doors factory assembled
- Coat rod included
- Overall dimensions: 69" w x 18" d x 78" h
- Compartments are 12" w x 18" d x 12" h

No. 5990 – Shipped Knocked Down

No. 5990SU – Shipped Set Up



Four-Door Horizontal Section Mounts to wall

45" w x 18" d x 13¾" h

No. 5991CR – Shipped Knocked Down

No. 5991CRSU – Shipped Set Up



Antimicrobial lockers are recommended for healthcare, food processing facilities, and educational facilities of all types.

Antimicrobial steel lockers provide continuous, residual protection against the touch transfer of bacteria on the locker surface, as well as colonization of mold and bacteria in locker corners, seams and on hidden surfaces behind and under the locker.

- Agion™ antimicrobial advanced powder technology
- 20+ years of antimicrobial protection
- Single and double tier openings
- Other sizes available upon request

Antimicrobial Lockers Feature:

- Antimicrobial coating
- Recessed handles
- Smooth fronts (no louvers)
- Sloping tops and
- E-Zee™ style locker base

Color Selection

UG Monorail Gray

Additional colors are available upon request

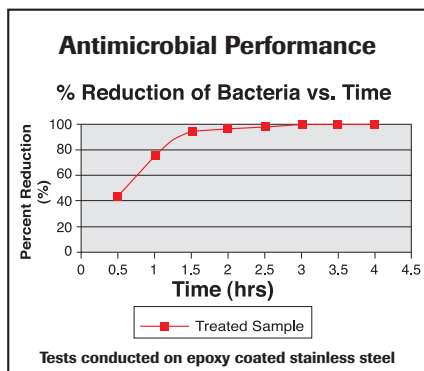

W x D x H* (per locker opening)	No. of Frames	No. of Openings	Knocked Down Cat. No.	Set Up Cat. No.
Single Tier				
15" x 18" x 72"	1	1	UGRNS5062H	UGRNS5062HSU
15" x 18" x 72"	3	3	UGRNS50623H	UGRNS50623HSU
18" x 18" x 72"	1	1	UGRNS5092H	UGRNS5092HSU
18" x 18" x 72"	3	3	UGRNS50923H	UGRNS50923HSU
Double Tier				
12" x 12" x 36"	1	2	UGRNS5202H	UGRNS5202HSU
12" x 12" x 36"	3	6	UGRNS52023H	UGRNS52023HSU
12" x 18" x 36"	1	2	UGRNS5222H	UGRNS5222HSU
12" x 18" x 36"	3	6	UGRNS52223H	UGRNS52223HSU

*Heights shown do not include E-Zee™ Base – add 4" to height for E-Zee™ Base. Sloping Top adds 6" to height for 18"D locker. Sloping Top adds 4" to height for 12"D locker. NOTE: E-Zee™ Base ships knocked down. Some easy assembly is required.



How Does it Work?

Any moisture triggers the controlled release of powerful silver ions (see charts) to provide superior antimicrobial protection for decades. The antimicrobial compound is completely inorganic, less toxic than ordinary table salt, less irritating than talcum powder, and has been approved by the EPA, FDA and NSF for medical devices and food contact applications.

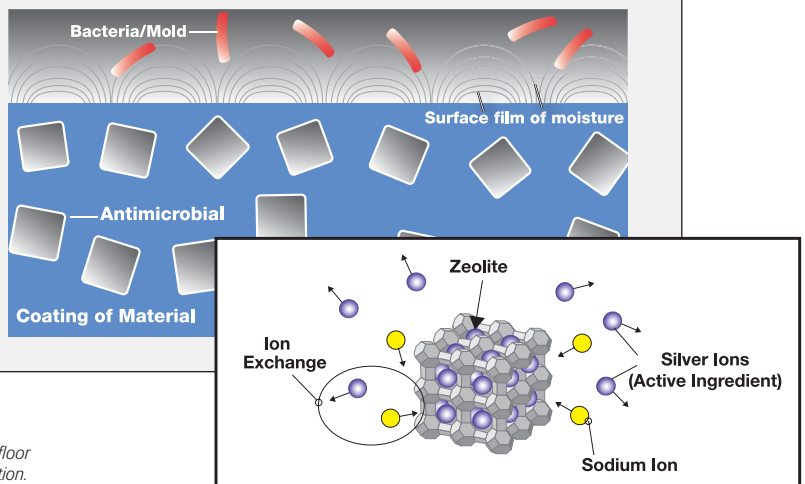

NOTE: In the interest of safety, Lyon strongly recommends that lockers be floor and/or wall anchored. See page 92 for important locker anchoring information.



Anchoring Systems

Important: In the interest of safety, Lyon strongly recommends that lockers be floor and/or wall anchored.

Anchoring Angle

For Lockers Without Legs

Locker Anchoring Angles (running from front to rear on the inside bottom of the locker) provide a bearing surface for the fasteners which are connected to the floor or locker base. Order one locker anchoring angle for each end of a row, plus sufficient quantity to provide angles on 36" centers. On single-row installations where backs are against a wall, lockers should be suitably wall anchored.

- No. 5872** – For 12"d lockers - 10 pack
- No. 5873** – For 15"d lockers - 10 pack
- No. 5874** – For 18"d lockers - 10 pack
- No. 5875** – For 21"d lockers - 10 pack

For more details – see assembly instructions packed with lockers.



Locker Foot

For Lockers With Legs

When backs are exposed (free-standing) a locker foot is recommended for all locker legs. When backs are against a wall and suitably wall anchored, locker feet are recommended on front legs only.

- No. 5870** - 10 pack



Number Plates

- Etched black figures on aluminum plate
- Numbers stocked from 1 to 999

Size: 2¾" w x 1" h

(Must be purchased in addition to locker order.)

For Lockers and Baskets
No. 5829



Touch-up Paint

For fast, easy touch-ups. Choose 12 oz. spray can.

Dove Gray
No. DD7003

Putty
No. PP7003

Wedgewood Blue
No. BB7003

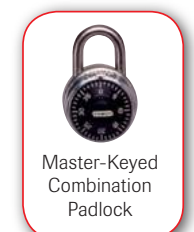

Lock Options

Can be used with all locker handles, and retrofitted to existing installations.

Safe-O-Mat Locking System – A coin-deposit locking system. Designed to be installed like a built-in combination lock. Can be retrofitted to most existing lockers. Available from manufacturing schedules only.

Flat-Key Locks – Same lock fits all Lyon Lockers except Personal Effects & ExchangeMaster®. Easy to install and furnished with two keys. **No. 7020**

Built-in Combination Locks – Five combinations per lock with master key for emergency access.

Combination Padlocks – For use with Tamper Guard Handles, Single Point Latching Systems, Recessed Handles and Pull Handles.

**Locks are imported.*

Color Selection

In Stock



Dove Gray



Putty



Additional colors are available upon request

Top and Front Fillers

Used to close space between two lockers when obstruction prevents installation of a locker. Can be furnished on flat or sloping tops.

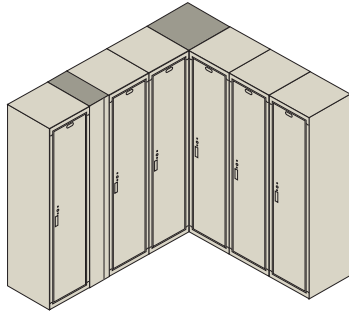

Flat Top Fillers

W x D	Cat. No.
For Corners	
12" x 12"	5900
15" x 15"	5901
18" x 18"	5902
21" x 21"	5898
For Tops of Lockers	
9½" x 12"	5922
9½" x 15"	5923
9½" x 18"	5924
15½" x 12"	5925
15½" x 15"	5926
15½" x 18"	5927

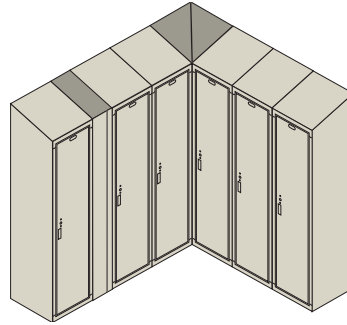

Sloping Top Fillers

W x D	Cat. No.
For Corners	
12" x 12"	5903
15" x 15"	5904
18" x 18"	5905
21" x 21"	5899
For Tops of Lockers	
9½" x 12"	5916
9½" x 15"	5917
9½" x 18"	5918
15½" x 12"	5919
15½" x 15"	5920
15½" x 18"	5921

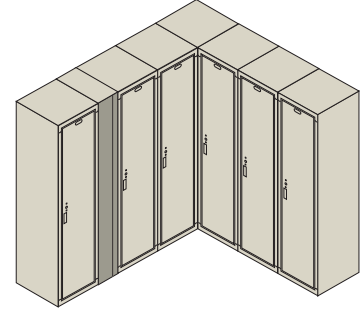

Front Expansion Fillers

W x D	Cat. No.
For Lockers With 6" Legs	
7½"w x 66"h	5906
7½"w x 78"h	5907
13½"w x 66"h	5910
13½"w x 78"h	5911
For Lockers Without Legs	
7½"w x 60"h	5912
7½"w x 72"h	5913
13½"w x 60"h	5914
13½"w x 72"h	5915



Note: Lockers with Integral Sloping Tops are available from manufacturing schedules at a slight additional cost.

Individual Slope-Top Kits

Quickly convert standard flat top steel lockers into sloping-top lockers. Includes hardware and instructions.

Slope-Top Kits include:

- tops and ends
- interim supports

Slope-Top Bulk Pack consist of:

- 40 slope tops
- 40 interim supports

Bulk pack ends (20 pairs) must be ordered separately.

Sizes W x D	Kits		Bulk Packages	
	Cat. No.	Cat. No.	Cat. No.	Cat. No.
	1-Wide	3-Wide	Tops (40 Pack)	Pair of Ends (20 Pack)
12" x 12"	58301	5830	5841	5842
12" x 15"	58311	5831	5846	5847
12" x 18"	58321	5832	5851	5852
15" x 15"	58331	5833	5856	5847
15" x 18"	58341	5834	5861	5852
18" x 18"	58351	5835	5866	5852
18" x 21"	58361	5836	N/A	N/A

Not designed for use on welded lockers.

Closed Style Bases

Quickly attach without tools to lockers with 6" legs. For Standard Lockers.



Front Bases

One Pack

No. 5800-1 – 12"w x 6"h

No. 5801-1 – 15"w x 6"h

No. 5802-1 – 18"w x 6"h

Three Packs

No. 5800-3 – 12"w x 6"h

No. 5801-3 – 15"w x 6"h

No. 5802-3 – 18"w x 6"h

End Bases

Only required at exposed ends.

Pack of 2

No. 5803 – 12"d x 6"h

No. 5804 – 15"d x 6"h

No. 5805 – 18"d x 6"h

No. 5806 – 21"d x 6"h



All Aluminum Locker Room Benches

- Sleek, new contemporary design
- Lightweight, corrosion resistant anodized aluminum bench and pedestals meet virtually any requirement for strength and durability
- Easy to maintain 9½" w x 2" h bench planks have softly rounded edges and center braces for comfortable seating
- Optional rubber feet and/or concrete wedge anchors
- Weight capacity 120 lbs. per linear foot

Note: Each pedestal shall be attached to top by screws and shall be anchored to floor by suitable anchors.

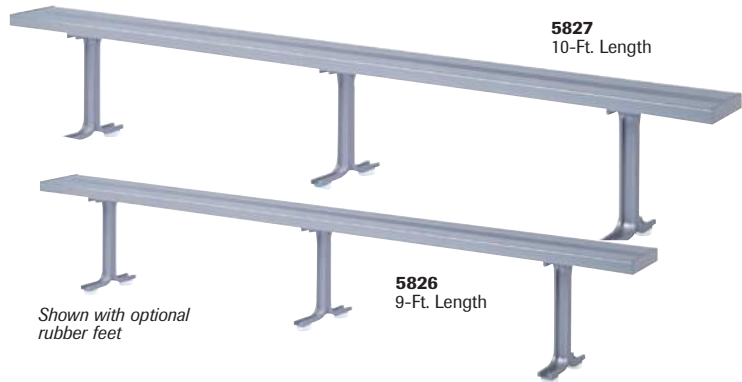

Hardwood and Plastic Laminate Top Locker Room Benches

- Selected hardwoods or smooth plastic laminates deliver strength and beauty
- Lightweight, anodized aluminum or painted steel pedestals
- Painted steel pedestals are stocked in Dove Gray and Putty
- Eight different sizes, from three feet to ten feet in length deliver all the versatility, styling and performance required
- Weight capacity 150 lbs. per linear foot

Note: Each pedestal shall be attached to top by screws and shall be anchored to floor by suitable anchors.



Description	Size (W x D x H)	Cat. No.
All Aluminum Benches		
6-Ft. Bench w/ 2 pedestals	72" x 9½" x 17⅝"	5824
8-Ft. Bench w/ 2 pedestals	96" x 9½" x 17⅝"	5825
9-Ft. Bench w/ 3 pedestals	108" x 9½" x 17⅝"	5826
10-Ft. Bench w/ 3 pedestals	120" x 9½" x 17⅝"	5827
Hardwood on Painted Steel Pedestals		
3-Ft. Bench w/ 2 pedestals	36" x 9½" x 18"	5793
4-Ft. Bench w/ 2 pedestals	48" x 9½" x 18"	5794
5-Ft. Bench w/ 2 pedestals	60" x 9½" x 18"	5795
6-Ft. Bench w/ 2 pedestals	72" x 9½" x 18"	5810
7-Ft. Bench w/ 2 pedestals	84" x 9½" x 18"	5797
8-Ft. Bench w/ 2 pedestals	96" x 9½" x 18"	5811
9-Ft. Bench w/ 3 pedestals	108" x 9½" x 18"	5812
10-Ft. Bench w/ 3 pedestals	120" x 9½" x 18"	5813
Plastic Laminate on Painted Steel Pedestals		
6-Ft. Bench w/ 2 pedestals	72" x 12" x 18"	5815
10-Ft. Bench w/ 3 pedestals	120" x 12" x 18"	5817
Steel Pedestals		
Steel Pedestals only (2-pack)	N/A	58182
Steel Pedestals only (3-pack)	N/A	58183
Hardwood on Aluminum Pedestals		
3-Ft. Bench w/ 2 pedestals	36" x 9½" x 16⅝"	5783
4-Ft. Bench w/ 2 pedestals	48" x 9½" x 16⅝"	5784
5-Ft. Bench w/ 2 pedestals	60" x 9½" x 16⅝"	5785
6-Ft. Bench w/ 2 pedestals	72" x 9½" x 16⅝"	5786
7-Ft. Bench w/ 2 pedestals	84" x 9½" x 16⅝"	5787
8-Ft. Bench w/ 3 pedestals	96" x 9½" x 16⅝"	5788
9-Ft. Bench w/ 3 pedestals	108" x 9½" x 16⅝"	5789
10-Ft. Bench w/ 3 pedestals	120" x 9½" x 16⅝"	5790

ACCESSORIES AND RELATED PRODUCTS

Aluminum Bench Accessories



Rubber Feet

Add 1" to aluminum pedestal height. (Optional)

No. 58224 - 4-pack

No. 58226 - 6-pack



Aluminum Pedestals (Shown with optional rubber feet)

Pedestals are 15¼" high.

No. 58202 - 2-pack

No. 58203 - 3-pack



Concrete Wedge Anchors

For aluminum pedestals are ⅜" w x 2¼" d.

No. 58234 - 4-pack

No. 58236 - 6-pack

Moveable Aluminum Trapezoid Pedestals

No. 58282 - 2-pack

No. 58283 - 3-pack

*Bench top not included

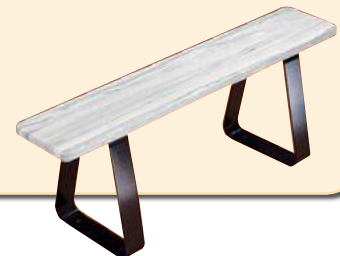

TA-50 Gear Lockers

This heavy-duty, fully-ventilated and all-welded locker is the ultimate storage solution. Inspired for government and military grade gear and equipment, this locker withstands harsh usage.

Formed-steel panels and strategic diamond-perforation of the doors, back and sides maximize the strength and rigidity of the locker.

- Heavy-gauge “unibody” construction
- 16-gauge steel top with 14-gauge reinforced bottom, back, doors and sides
- Chrome-plated, pad-lockable handle with a high security three-point latching system
- 16-gauge steel shelf with center reinforcing channel for a 200 lb. capacity
- Pre-punched holes in back, sides, and bottom for attaching lockers to each other and/or to the wall or floor
- 1" coat rod and 4 coat hooks to hang coats, uniforms and heavy field dress
- Overall locker: 42"w x 24"d x 78"h

No. 1100TA50

No. 1100TA50G - Galvannealed

Color Selection

DD Dove Gray
PP Putty

Additional colors are available upon request



Command Gear Lockers

This heavy-duty, all-welded locker offers a unique solution for storage and protection. The original design was inspired by military pilot's flight-related equipment storage needs.

- Open storage area for flight helmets
- Lockable upper storage compartment for personal effects
- Aluminum 3-1/2" x 2-1/4" label holder
- Heavy duty, 18-gauge, 5/8" diameter hanging rods for flight gear, plus two side hooks for lighter gear
- Ventilated sides
- Large compartment to house the torso harness, G-suit/G-vest, survival vest and related flying equipment jacket and helmet bags
- Lockable lower storage compartment for additional equipment
- Shipped set up
- Overall locker: 24"w x 24"d x 72"h

No. RN5187W - one wide



Hill Air Force Base, Utah. Shown with field supplied pads. Pads not included.

Lockers in photos are custom painted in Flight Squadron colors. Call customer service to order lockers in your squadron colors.



VALOR™ LAW ENFORCEMENT LOCKERS have customizable shelving components that maximize the storage space to meet the needs of officers. Each component ships separately and must be assembled on-site. Factory assembly is available please contact customer service for more details.

- Large: Upper Locker Unit -** 24" w x 24" d x 72" h
- Large: Lower Drawer Unit -** 24" w x 36" d x 18" h
- Small: Upper Locker Unit -** 18" w x 24" d x 72" h
- Small: Lower Drawer Unit -** 18" w x 36" d x 18" h

Electrical Feed Punch Outs for optional electric capability within locker

Horizontal Vest Storage for Kevlar® vests which are recommended to be stored horizontally

Partition Kit: Full width shelf (up to three shelves can be added), partition, two utility hooks, and coat rod

Personal Security Compartments are padlock, digital or combination lock ready for instant security

Shelf offers a flat area for small item storage and easy access

Vertical Storage with double prong hooks

Boot Drawer Latch provides quick and easy access to boot drawer and auto locking capability when the drawer is closed

Horizontal Vest Storage Shelf provides horizontal storage for Kevlar® vests in the lower drawer unit

Perforated Ventilation in all compartments allows for airflow throughout the locker, keeping contents cool and dry

Hat & Briefcase Storage Compartment accommodates larger items. Additional shelves are available

Stand Alone Security Compartments are all welded construction and may be secured above or below a full width shelf **only** when a partition kit is not used

Belt Utility Hooks for hanging a variety of duty belts

Door Mirror with magnetic backing can be positioned right where it is needed

Hat & Uniform/Garment Storage has ample space with coat rack and two utility hooks for uniforms, coats and civilian clothes

Boot Tray is perforated and removable for ease of use and cleaning

Hardwood Bench offers a convenient place to sit when removing shoes, boots or gear

Lower Drawer Unit provides ample storage for boots, duffle bags and larger gear



VALOR™ LOCKER ORDERING GUIDE

Step 1 - Determine the width needed for your locker requirements. Lockers are offered in 18" or 24" wide.

Step 2 - Select upper shell configuration
Configuration A - A partition kit comprised of; two utility hooks, a coat rod, a partition and full width shelf. This option will support all personal compartment options.

Configuration B - Choose full width shelves and/or stand alone security compartments to fill this locker requirement.

Step 3 - Determine if a Lower Unit Boot Drawer is required. A boot drawer is equipped to provide storage for larger gear and has a hardwood bench top* that provides a seating option when changing. A vest shelf may also be added to the lower drawer unit.

Step 4 - Select Additional Locker Door Options
 • belt clips • clip board holder • magnetic mirror

*For multiple locker runs, Lyon recommends purchasing by linear foot. For a quote, contact customer service.

Step 1

18" Locker Units and Options

Size	Description	Cat. No.
18"w x 24"d x 72"h	Upper Unit Shell	VL5104

24" Locker Units and Options

Size	Description	Cat. No.
24"w x 24"d x 72"h	Upper Unit Shell	VL5578

Step 2 Configuration A

Upper Unit Partition Kit consists of the following components <i>(to configure locker using partition kit see personal compartment options below)</i>		
18"w x 24"d	Partition Kit	VL1858PT
18"w	Full Width Shelf†	
-	Two Utility Hooks	
10"w	Coat Rod	
Upper Unit options AVAILABLE ONLY WITH a Partition Kit		
Personal Compartment Options		
8"w x 8"h	Security Compartment Door Kit**	VL0808LU
8"w x 8"h	Two Drawer/Shelf Kit** <i>(not pictured)</i>	VL0808DRW
8"w x 24"d	Compartment Shelf	VL0808
-	Double Prong Hook	NF6712
Boot Tray Options		
10"w x 24"d	Boot Tray	VL184BT

Step 2 Configuration A

Upper Unit Partition Kit consists of the following components <i>(to configure locker using partition kit see personal compartment options below)</i>		
24"w x 24"d	Partition Kit	VL2458PT
24"w	Full Width Shelf†	
-	Two Utility Hooks	
16"w	Coat Rod	
Upper Unit options AVAILABLE ONLY WITH a Partition Kit		
Personal Compartment Options		
8"w x 8"h	Security Compartment Door Kit**	VL0808LU
8"w x 8"h	Two Drawer/Shelf Kit** <i>(not pictured)</i>	VL0808DRW
8"w x 24"d	Compartment Shelf	VL0808
-	Double Prong Hook	NF6712
Boot Tray Options		
16"w x 24"d	Boot Tray	VL244BT

Step 2 Configuration B

Upper Unit Options AVAILABLE ONLY WITHOUT a Partition Kit		
Upper Shelf Options		
18"w	Full Width Shelf†	VL184SS
18"w	Vest Shelf†	VL184VS
Stand Alone Security Compartment		
8"w x 12"d x 11"h	Stand Alone Security Comp.††	VL081211
12"w x 20.625"d x 11"h	Stand Alone Security Comp.††	VL122411

Step 2 Configuration B

Upper Unit Options AVAILABLE ONLY WITHOUT a Partition Kit		
Upper Shelf Options		
24"w	Full Width Shelf†	VL244SS
24"w	Vest Shelf†	VL244VS
Stand Alone Security Compartment		
8"w x 12"d x 11"h	Stand Alone Security Comp.††	VL081211
12"w x 20.625"d x 11"h	Stand Alone Security Comp.††	VL122411

Step 3 Lower Drawer Unit

18"w x 36"d x 18"h	Lower Drawer Unit	VL1836DRW
18"w x .75"h	18"w Hardwood Bench Top	100760-18X.75
18"w x 24"d	Vest Shelf for Lower Drawer Unit	VL1836DV

Step 3 Lower Drawer Unit

24"w x 36"d x 18"h	Lower Drawer Unit	VL2436DRW
24"w x .75"h	24"w Hardwood Bench Top	100760-24X.75
24"w x 24"d	Vest Shelf for Lower Unit Drawer	VL2436DV

Step 4

Accessories for BOTH 18" and 24" Base Lockers

Locker Door Options		
-	Clip Board Holder <i>(not pictured)</i>	VL0808CB
7"w x 11"h	Mirror with Magnetic Backing	NFVLMIRROR
-	Belt Clips, (3-pack)	NFVLHOOK

† Up to two additional shelves may be used above the partition kit.

** A compartment shelf (No. VL0808) is necessary to close the tops of these items unless mounted directly below full shelf.

†† A stand alone security compartment may be secured above or below a full width shelf when a partition kit is not used. (Please review with Lyon sales representative when ordering to confirm correct configuration).



MVP Athletic Locker is a requirement for any athletic team. With an open-front design, the over-sized MVP Locker provides a large, closet-type space for clothing and uniforms and an optional foot locker for equipment storage. An upper shelf is ideal for small items, while the optional lockable compartment adds secure storage for valuables. Heavy gauge steel body parts and our premium paint finish guarantee durability in the demanding environment of a team room.

Standard Features

- **Material:** Body - 16 ga. mild cold rolled steel (backs 18 ga. on KD units).
- **Assembly:** Knocked down (KD), assembled with rivets or nuts and bolts.
- **Interior Equipment:**
1 full width 16 ga. shelf,
4 single prong coat hooks
and a coat rod.



- **Ventilation:** Diamond perforated sides - solid sides can be requested for either row ends or all sides.



Optional Features

- **Material:** Body - 16 ga. galvanized steel.
- **Assembly:** Knocked down (KD), assembled with Keps nuts and bolts; Pre-assembled of welded construction (backs are 16 ga.). Optional lockable compartment and/or foot locker are not welded into assembly.
- **Interior Equipment:**



Foot Locker - Fully enclosed foot locker with 14 ga. ventilated front panel and reinforced seat with continuous hinge. Front panel has recessed area and mounted padlock hasp for locking.



Lockable Compartment - 16 ga. vertical partition and 14 ga. door with framing members attached to the shelf, side, and top of the locker to provide lockable storage. Spring hinge holds door closed for safety. Door punched to accept padlock or built-in lock.

door closed for safety. Door punched to accept padlock or built-in lock.

Configurations and Sizes:

Basic MVP



W: 18, 24
D: 18, 21, 24
H: 72

MVP with Foot Locker

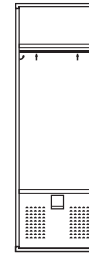

W: 18, 24
D: 18, 21, 24
H: 72

MVP with Lockable Compartments



W: 18, 24
D: 18, 21, 24
H: 72

Complete MVP

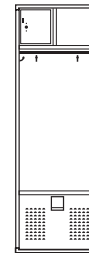

W: 18, 24
D: 18, 21, 24
H: 72

Deluxe Collegiate & Collegiate Lockers

SPECIFICATION SUMMARY

All-Welded

- All seams and Joints welded for rigidity
- Optional compartments shipped knocked down
- 16-gauge body parts with 18-gauge backs
- Full loop type hinges
- Powder coat finish
- 14-gauge sheet metal or no door compartments
- 16-gauge frame
- 16-gauge sheet metal
- All metal locking systems
- Optional installation of compartments at factory
- Stainless steel recessed handle

Knocked Down

- 14-gauge sheet metal or 16-gauge sheet metal or no door
- 16-gauge frame
- 16-gauge sheet metal sides
- All metal locking systems
- Stainless steel recessed handle
- Powder coat finish

*Specify All-Welded or Knock Down at time of order



Features

A- Deluxe Collegiate Lockers offer additional security for special equipment or assigned gear. 18" high interior compartment bench with padlock hasp. Upper compartment door may also be equipped with built-in key or combination lock.

B- Deluxe Collegiate Lockers with Doors offer the same design and construction features as above, plus the added security of a reinforced door.

C- Collegiate Lockers are designed to provide easy access to equipment and uniforms in team locker rooms. Shelf included.

D- Collegiate Lockers with Doors are recommended for storing bulky uniforms of hockey and football teams, offering up to 36" wide compartments.

Includes solid back and diamond perf sides. Optional diamond perforated door. Is also available as solid or louvered door.

Handles



All doors feature Stainless Steel Recessed Handles with built-in padlock attachment. Zinc alloy recessed handle or turn handles are also available as an option. Recessed handles are designed to also accommodate built-in combination and digital locks. Not provided on bulk or security boxes with lockbar.

Configurations

Deluxe Collegiate Lockers

W: 24, 33, 36
D: 18, 21, 24
H: 72, 84



Deluxe Collegiate Lockers with Doors

W: 24, 33, 36
D: 18, 21, 24
H: 72, 84



Collegiate Lockers

W: 24, 33, 36
D: 18, 21, 24
H: 72, 84



Collegiate Lockers with Doors

W: 24, 33, 36
D: 18, 21, 24
H: 72, 84





Cubbie Lockers for Kids

Meet the storage needs for daycare centers, preschools and elementary schools.

Feature antimicrobial powder paint finish that fights bacterial growth and corrosion on locker surfaces in the classroom.

16" Leg Lockers
16" high legs make mopping or hosing floors easier when required. Legs also provide support for benches.



Ski Lockers

Ski Lockers are ideal for seasonal rentals at resorts and in ski area hotels and condominiums. The locker is 84" in height and with the optional sloping top, can hold skis up to 225 cm in length. Optional equipment includes stainless steel bottoms; slide stops to prevent skis from sliding out of lockers; hooks for hanging poles; and half shelves for hats, gloves, or goggles.



ABC Cubbie for Kids

ABC Cubbies for Kids meet the casework needs of daycare centers, pre-primary and elementary schools with the colorful, durable traits of steel lockers. Manufactured from heavy gauge steel, with no doors or locks for simplicity, Cubbies are designed for safety with 180 degree bends, round corners, and smooth edges. For a colorful, long lasting, and fast installing alternative to casework, choose ABC Cubbies for Kids.

Single Compartment w/Shelf



W: 12, 15, 18
D: 15
H: 48

Double Compartment

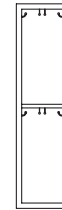

W: 12, 15, 18
D: 15
H: 24

Companion Compartment



W: 12, 15, 18
D: 15
H: 48

Triple Compartment



W: 12, 15, 18
D: 15
H: 16

Other Special Application Lockers

- Front/rear entry lockers for uniform exchange or legal evidence
- Combination lockers with variable compartment sizes
- Lockers without doors for divided, open storage
- Combination fire extinguisher and waste can doors

PERSONAL EFFECTS LOCKERS

Perfect for limited spaces where employees need a secure place to store their belongings. All steel construction provides secure storage in a wide range of applications; restaurants, convenience stores, hospitals, service stations and small manufacturing plants.

- 4 Person, and 8 Person Lockers - Doors: 20-gauge; Door frames: 16-gauge
- 9 Person, and 10 Person Lockers - Doors: 22-gauge; Door frames: 16-gauge
- Shipped set up, ready to use

Color Selection

DD Dove Gray

NOTE: Key Locks are not available for Personal Effects Lockers.



9 Person Privacy Locker

- Big Compartments for packages, lunch boxes, etc.
- Each compartment can store up to six folded uniforms

10 Person Privacy Locker

- Takes up less than 1½ square feet of floor space
- Ideally suited for smaller parcels and smaller items such as purses, books and lunches

4 Person Apparel Locker

- Ideal for bulky garments, coveralls or situations where additional width is necessary
- Louvered doors for ventilation

8 Person Apparel Locker

- Takes up less than five square feet of floor space
- Individual compartments equipped with a coat rod

Description	Compartment W x D x H	Door Opening W x H	Overall Size W x D x H	Cat. No. with Padlock Attachment*	Cat. No. with Combination Lock
9 Person Privacy Locker	23-7/8" x 13-3/4" x 8-3/4"	18-1/8" x 8-3/4"	24" x 15" x 84"	6309PLA	6309C
10 Person Privacy Locker	17-7/8" x 13-3/4" x 7-1/4"	12-1/8" x 7-1/4"	18" x 15" x 78"	6310PLA	6310C
4 Person Apparel Locker	12-3/8" x 19-7/4" x 41-1/2"	9-3/4" x 38-3/4"	26" x 21" x 84"	6304WPLA	6304WC
8 Person Apparel Locker	7-1/2" x 19-7/8" x 41-1/2"	6-1/2" x 38-3/4"	32-9/16" x 21" x 84"	6308WPLA	6308WC

*Padlock not included.

NOTE: In the interest of safety, Lyon strongly recommends that lockers be floor and/or wall anchored. See page 92 for important locker anchoring information.

Folded Garment/Linen Lockers

Individual patron doors have a choice of three different locking systems. Service door has H-1 industry standard lock. Nine-compartment lockers typically hold up to seven average size folded garments. Ten and sixteen-compartment lockers, respectively, hold five and two average size folded garments or accommodate small personal items in less than two square feet of floor space.

- Door frames: 16-gauge, Doors: 22-gauge

Color Selection

DD Dove Gray



Description	Compartment W x D x H	Door Opening W x H	Overall Size W x D x H	Cat. No. with Key Lock	Cat. No. with Combination Lock	Cat. No. with Turn Lock
Nine Compartment Locker	23 ⁷ / ₈ " x 13- ³ / ₄ " x 8 ³ / ₄ "	18 ¹ / ₈ " x 8 ³ / ₄ "	24" x 15" x 84"	6409	6409C	6409TL
Ten Compartment Locker	17 ⁷ / ₈ " x 13- ³ / ₄ " x 7 ¹ / ₄ "	12 ¹ / ₈ " x 7 ¹ / ₄ "	18" x 15" x 78"	6410	6410C	6410TL
Sixteen Compartment Locker	17 ⁷ / ₈ " x 13- ³ / ₄ " x 4 ¹ / ₂ "	12 ¹ / ₈ " x 4 ¹ / ₂ "	18" x 15" x 78"	6416	6416C	6416TL

Swinging panel at top allows items to be dropped into lower compartment



ACCESSORIES AND RELATED PRODUCTS



Number Plates

Etched black figures on aluminum plate.

No. 5829

Soiled Items Disposal

- Swinging panel at top allows items to be dropped into lower compartment. Also serves as mail drop
- Main door remains locked until opened by authorized personnel
- Back is perforated for ventilation
- Multi-point latching system key-control lock
- Door frames: 16-gauge, Swing door panels: 18-gauge, Doors: 20-gauge

No. 6401X - 18"w x 15"d x 78"h

No. 6401XL - 26"w x 21"d x 84"h

No. HH6401XL - 26"w x 21"d x 43-1/8"h

NOTE: In the interest of safety, Lyon strongly recommends that lockers be floor and/or wall anchored. See page 92 for important locker anchoring information.



Hanging Garment Lockers

Choose from multiple configurations to secure uniforms, coveralls, smocks and other protective clothing. Provide space for four to eight people per unit with individual lockable compartments — plus master door access for servicing by a supervisor or supplier. Compact pre-engineered designs with your choice of locking systems adapt quickly to specific applications in a wide range of facilities.

- Compact design allows units to be installed near service or work areas, eliminating the need for secured storage rooms
- Garment and linen inventories can be accurately controlled and “shrinkage” minimized
- Door frames: 16-gauge, Doors: 20-gauge
- Shipped set up, ready to use with sturdy, pop-rivet construction

Color Selection

DD Dove Gray

Locks



Key Lock -
Includes 2 keys and is standard on all patron doors. Locks easily replaced. All key and locks are numbered. Replacement locks and keys in stock.



Built-In Combination Lock
Complete with one combination per lock. Additional combinations by serial number provided upon request. A master control key is available upon request.



Turn Lock -
provides easy door opening with a simple twist. If greater security is required, turn lock can accept a padlock to provide a fully locked compartment door.

Description	Compartment W x D x H	Door Opening W x H	Overall Size W x D x H	Cat. No. with Key Lock	Cat. No. with Combination Lock	Cat. No. with Turn Lock
Four Hanging Garment Locker	12 ³ / ₈ " x 19 ⁷ / ₈ " x 41 ¹ / ₂ "	9 ¹ / ₂ " x 38 ³ / ₄ "	26" x 21" x 84"	6404W	6404WC	6404WTL
Six Hanging Garment Locker	8" x 19 ⁷ / ₈ " x 41 ¹ / ₂ "	6 ¹ / ₂ " x 38 ³ / ₄ "	26" x 21" x 84"	6406	6406C	6406TL
Eight Hanging Garment Locker	5 ⁷ / ₈ " x 19 ⁷ / ₈ " x 41 ¹ / ₂ "	4 ¹³ / ₁₆ " x 38 ³ / ₄ "	26" x 21" x 84"	6408	6408C	6408TL
Widebody Eight Hanging Garment Locker	7 ¹ / ₂ " x 19 ⁷ / ₈ " x 41 ¹ / ₂ "	6 ¹ / ₂ " x 38 ³ / ₄ "	32 ⁹ / ₁₆ " x 21" x 84"	6408W	6408WC	6408WTL

NOTE: In the interest of safety, Lyon strongly recommends that lockers be floor and/or wall anchored. See page 92 for important locker anchoring information.

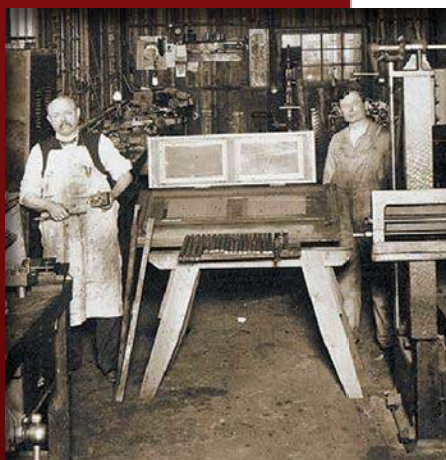
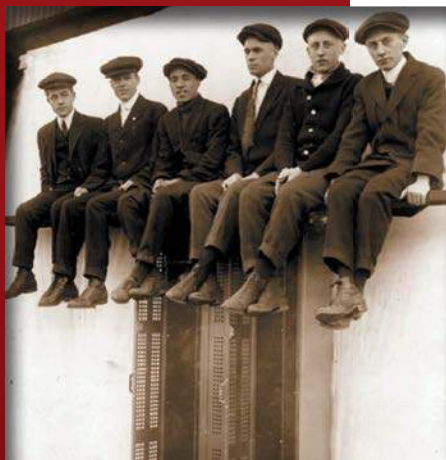

LYON ADVANTAGE

Over 117 years of commitment supporting our dealers, distributors and end users to store and organize their products while maximizing workspace storage.

20+ Solutions experts located throughout the USA providing immediate attention and support to every project.

Lifetime Product Warranty against defects in material and workmanship for the life of the product.

Three domestic plants centrally located in the USA. Thousands of products available in stock, ready to ship.

LEED/Green Focused

No hassle claims. Any Lyon product damaged in shipment by a Lyon designated carrier will be returned and Lyon will ship a replacement product in a timely manner. *Product damage must be noted on delivery receipt and damaged product must be refused at time of delivery.*

OUR MISSION

Be the storage system provider of choice by delivering the best possible workspace solutions for our customers. As a business with a rich heritage, we are passionately committed to helping our dealers, distributors and end-users store and organize their products while maximizing workspace.

OUR VISION

To stay the market leader in each of our served markets. This leadership will be captured by providing our dealers, distributors and end users high quality, innovative, cost-effective and environmentally friendly products. We add value to these products by providing unmatched customer service through our commitment to customer satisfaction.

LYON®

Cabinets • Lockers • Shelving

PO Box 671, Aurora, IL 60507-0671

p: 800-323-0082 f: 800-367-6681

e: lyon@lyonworkspace.com

lyonworkspace.com

Member of:

